

Linear SECURITY
DUAL 824

**SUPERVISED WIRELESS
SECURITY CONTROL PANEL**

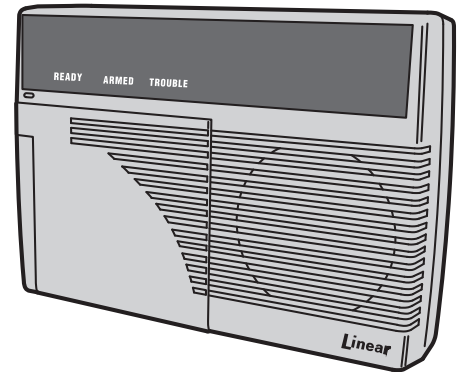
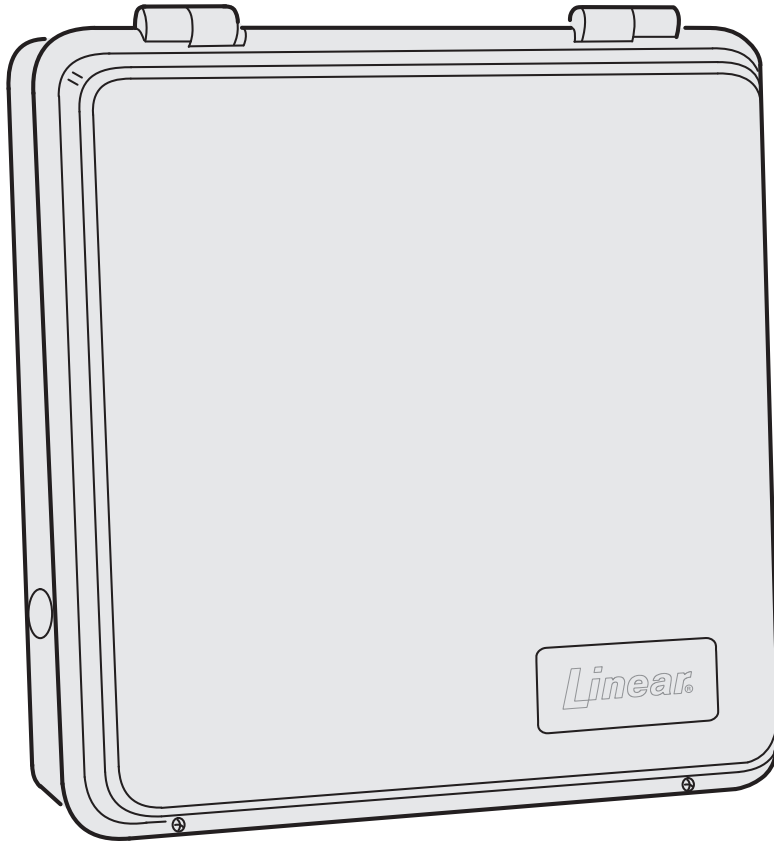

Installation & Programming Instructions

Linear
Building On Innovation.

USA & Canada (800) 421-1587 & (800) 392-0123
(760) 438-7000 - Toll Free FAX (800) 468-1340
www.linearcorp.com

INTRODUCTION

CONGRATULATIONS for selecting Linear's DUAL 824 Security System. The Model DUAL 824P Control Panel and the Model DUAL 824KP Keypad incorporate many advanced and sophisticated features. The system can be expanded and customized to fit the installation's specific needs.

The DUAL 824P Control Panel and its accessories are designed and manufactured by the oldest wireless security company in North America. You can look ahead to many years of reliable service with this Control Panel and its accessories.

Many insurance companies offer discounts on homeowners and renters policies when a security system is installed. Discount credits vary with different companies and generally increase in savings with an increase in the level of protection. Inform the user to ask their insurance agent about savings available.

The DUAL 824P Control Panel is UL Listed. For a UL smoke alarm system, there must be at least one smoke detector programmed into the Control Panel to meet National Fire Protection Association (NFPA) Rule 72 Chapter 2 and UL 217 requirements. Many insurance companies require these conditions to be met to qualify for a discount. Only use the Model DXS-73 smoke detector with this Control Panel for a UL smoke alarm system.

NOTE: Some cities and municipalities may require an alarm system permit. Check with the local authorities before installing this system.

In this manual, the bullets preceding the text help to define the information. For example:

- ◆ This symbol indicates a feature.
- * This symbol is for lit indications or system sounds.
- 📌 This symbol is for important notes.

DUAL 824 SYSTEM

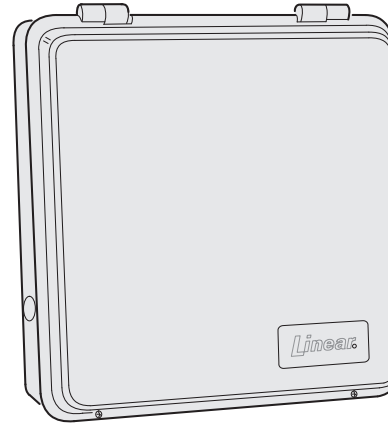

CONTROL PANEL
MODEL DUAL 824P

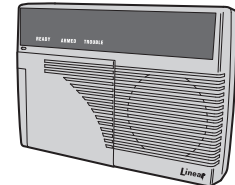

KEYPAD
MODEL DUAL 824KP



UL Listed as a Single Station Smoke Detector Accessory, also suitable as a Household Burglar-Alarm System Control Unit. UL Category CCN UTGT & NBSX

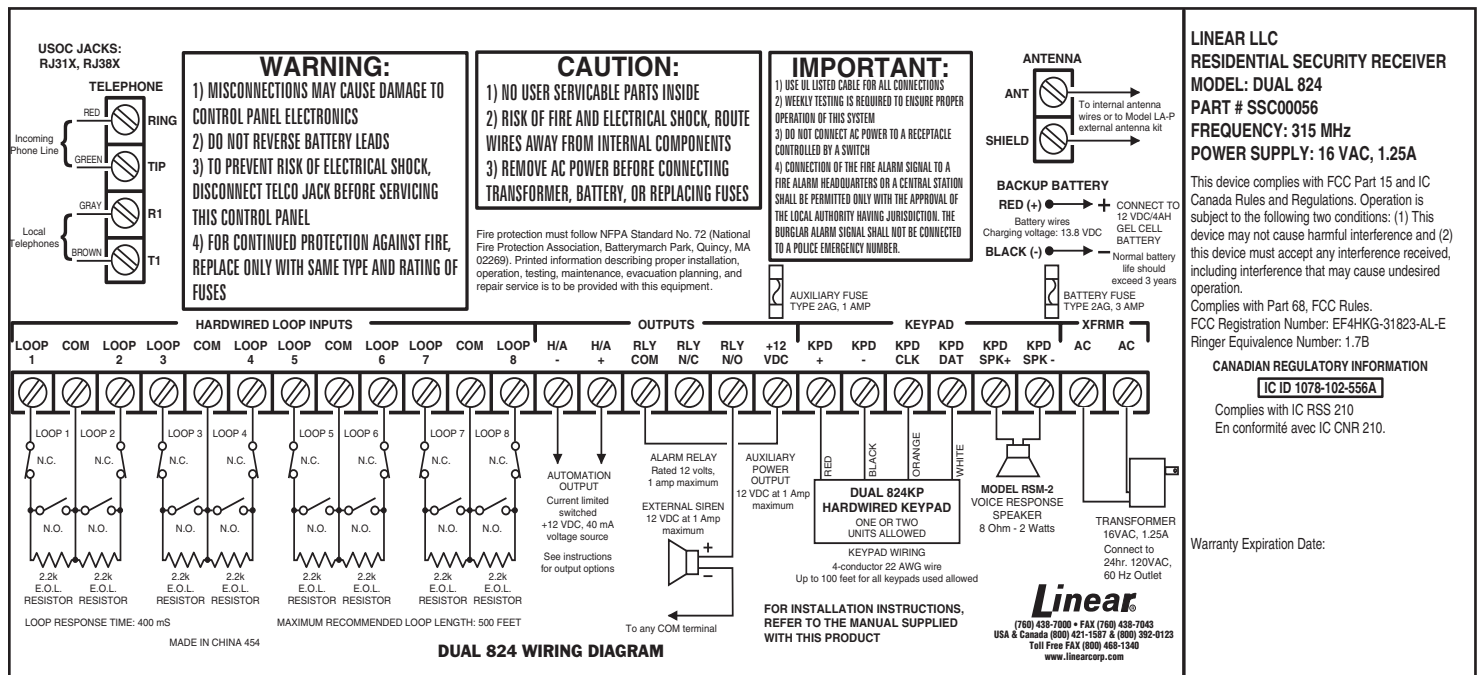

LINEAR LLC RESIDENTIAL SECURITY RECEIVER
MODEL: DUAL 824
PART # SSC00056
FREQUENCY: 315 MHz
POWER SUPPLY: 16 VAC, 1.25A

This device complies with FCC Part 15 and IC Canada Rules and Regulations. Operation is subject to the following two conditions: (1) This device must not cause harmful interference and (2) this device must accept any interference received, including interference that may cause undesired operation.

Complies with Part 68, FCC Rules.
FCC Registration Number: EF4HK-31823-AL-E
Ringer Equivalence Number: 1.7B

CANADIAN REGULATORY INFORMATION
IC ID 1078-102-556A
Complies with IC RSS 210
En conformité avec IC CNR 210.

Warranty Expiration Date:

TABLE OF CONTENTS

1. THE DUAL 824 SECURITY SYSTEM	2	13. ADVANCED PROGRAMMING	29
CONTROL PANEL	2	SETUP MODE	29
DOOR/WINDOW SENSORS	3	CHANGING A SENSORS SUPERVISION	30
WIRELESS KEYPAD	3	CHANGING A SENSORS RESTORE REQUIREMENTS	30
SMOKE DETECTOR	3	ENTRY DELAY TIME	30
REMOTE CONTROLS	3	EXIT DELAY TIME	30
GLASS BREAK DETECTOR	3	BURGLARY SIREN TIME	30
PANIC BUTTONS	3	EMERGENCY SIREN TIME	30
BILL TRAP	3	FIRE SIREN TIME	31
PASSIVE INFRARED MOTION DETECTOR	3	AUTOMATION OUTPUT TIME	31
2. SECURITY SYSTEM FLOOR PLAN	4	REMOTE CONTROL & HARDWIRE ARMING LEVEL	31
EXAMPLE SYSTEM	4	REMOTE CONTROL & HARDWIRE DISARMING LEVEL	31
DESIGN THE INSTALLATION	4	ENTRY DELAY BEEPS	31
3. OVERVIEW OF KEYPADS	5	EXIT DELAY BEEPS	31
HARDWIRED KEYPAD	5	SILENT BURGLARY ALARMS	32
WIRELESS KEYPAD	5	SILENT EMERGENCY ALARMS	32
ABOUT SENSOR STATUS SUPERVISION	5	DISABLING QUICK ARMING	32
4. HARDWIRED KEYPAD FEATURES	6	AUTOMATIC RESTORAL OF BYPASSED SENSORS	32
5. CONTROL PANEL FEATURES	7	AUTOMATIC BYPASSING OF OPEN SENSORS	32
6. CONTROL PANEL INSTALLATION	8	AUTOMATION OUTPUT MODE DURING ALARM	33
SYSTEM LOCATION	8	AUTOMATION ACTIVATION TONE	33
WALL MOUNTING	8	REMOTE CONTROL & HARDWIRE ARM/DISARM CHIRP	33
EXTERNAL ANTENNA	8	AUTOMATION OUTPUT ON DURING AND AFTER ALARM	33
HARDWIRED KEYPAD INSTALLATION	9	AUTOMATION OUTPUT ON DURING ALARM	33
HARDWIRED LOOP WIRING	10	AUTOMATION OUTPUT WHILE ARMED	34
ARM/DISARM KEY STATION WIRING	10	AUTOMATION OUTPUT DURING EXIT/ENTRY DELAYS	34
EXTERNAL ALARM SIREN CONNECTION	11	AUTOMATION OUTPUT POLARITY	34
TELEPHONE LINE CONNECTION	11	REMOTE ACCESS PASSWORD	34
AUTOMATION OUTPUT CONNECTION	12	DURESS CODE	34
VOICE RESPONSE MODULE	12	MASTER USER CODE	34
CONTROL PANEL POWER CONNECTION	13	ADDING ADDITIONAL USER CODES	35
BACKUP BATTERY INSTALLATION	13	REMOVING ADDITIONAL USER CODES	35
7. BASIC CONTROL PANEL PROGRAMMING	14	CONTROL PANEL MASTER RESET	35
CREATE THE MASTER USER CODE	14	14. COMMUNICATOR PROGRAMMING	36
PROGRAM THE HARDWIRED LOOPS	15	SETUP MODE	36
PROGRAM THE WIRELESS SENSORS	15	GENERAL COMMUNICATOR OPTIONS	37
PROGRAMMING DIFFERENT SENSOR TYPES	16	COMMUNICATOR ENABLE	37
8. BASIC SENSOR INSTALLATION	18	2-WAY AUDIO	37
DXS-10 WIRELESS KEYPAD	18	VOICE RESPONSE	37
DXS-31 & DXS-32 DOOR/WINDOW SENSORS	19	REMOTE LOCKOUT	37
TEST SENSORS	19	CALL LIMITER	38
9. CUSTOMIZING THE KEYPAD	20	DIALING DELAY	38
LABELING THE SENSOR LOCATIONS	20	DIALING METHOD	38
10. SYSTEM OPERATING MODES	21	COMMUNICATOR REPORTING OPTIONS	39
OFF MODE	21	REPORTING FORMAT	39
CHIME MODE	21	CALL ROUTING	39
HOME MODE	22	ACCOUNT NUMBER	40
SECURE EXIT	22	PRIMARY TELEPHONE NUMBER	40
HOME INSTANT MODE	22	SECONDARY TELEPHONE NUMBER	40
MANUAL BYPASSING OF SENSORS	22	SUPERVISORY OR PAGER TELEPHONE NUMBER	40
AWAY MODE	23	TELEPHONE NUMBER DELAYS AND SPECIAL CHARACTERS	40
MANUAL BYPASSING OF SENSORS	23	REPORT CONTROL PANEL TROUBLE	41
TEST MODE	24	REPORT FORCE ARMING	41
11. SYSTEM TROUBLE INDICATIONS	25	OPENING AND CLOSING REPORTS	41
CONTROL PANEL POWER	25	POINT ID REPORTING	41
WIRELESS SENSOR LOW BATTERIES	25	COMMUNICATOR REPORTING CODES	42
SENSOR RADIO TROUBLE	25	GENERAL REPORTING CODES	42
12. CUSTOMIZING THE SYSTEM	26	SYSTEM REPORTING CODES	43
ADDING SENSORS TO THE SYSTEM	26	FORCE ARMING REPORTING CODE	43
REMOVING SENSORS FROM THE SYSTEM	26	DURESS REPORTING CODE	43
MAKING A SENSOR A 24-HOUR DOOR CHIME	27	4 BY 2 FORMAT POINT ID REPORTING CODES	44
MAKING A SENSOR INTERIOR	27	4 BY 2 FORMAT POINT ID ALARM REPORT CODES	44
MAKING A SENSOR PERFORM A DIFFERENT FUNCTION	28	4 BY 2 FORMAT POINT ID TROUBLE REPORT CODES	44
		IMPORTANT INFORMATION	46
		LINEAR LIMITED WARRANTY	46
		WIRELESS PRODUCT NOTICE	46
		FCC NOTICE	46
		FCC TELEPHONE RULES AND REGULATIONS	46
		FIRE EVACUATION PLANNING	46
		INDUSTRY CANADA NOTICES	46

1. THE DUAL 824 SECURITY SYSTEM

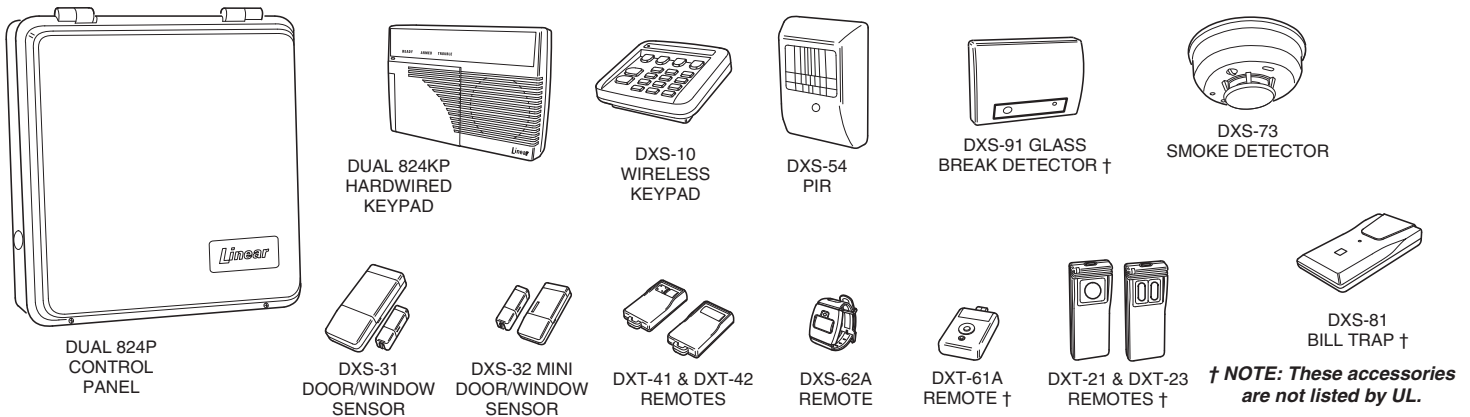

CONTROL PANEL

The DUAL 824P Control Panel is the heart of the system. It monitors all of the system's wireless sensors, hardwired loops, and controls the alarm sirens and Model DUAL 824KP hardwired keypads.

The Control Panel constantly monitors the condition of the system's sensors and hardwired contacts, displaying which protected doors and windows are open or closed. If an alarm occurs, the keypads display which sensor(s) caused it. When a sensor has a low battery, the keypads display which sensor needs a new battery. Sensors that send hourly status transmissions keep the Control Panel informed of their operating condition.

Up to eight different custom user codes can be used to operate the system. For security, a user code must be entered to disarm (turn off) the system. The system can be armed (turned on) by entering a user code, or with the unique "Quick Arm" feature. The five restricted user codes and the special page alert user code can only arm and disarm the system, no programming changes (except changing user and duress codes) are allowed. The master user code is allowed to program the Control Panel, and a duress code can be selected for emergency disarming of the system with a duress report to the Central Station. The page alert user code can dial a pager number to inform the pager wearer when the system is disarmed.

The Control Panel's memory will retain the user codes and all of the system's programming, even during a total power loss. An optional backup battery can be installed to power the system during short power failures.

The built-in digital communicator connects the Control Panel to a Central Alarm Monitoring Station through the telephone. With a monitored system, the central station can dispatch authorities in case of burglary, fire or other emergency. The central station can also call family, friends, neighbors, or anyone else designated on a custom call list. System arming (closing) and disarming (opening) reports by user can also be sent.

Each sensor can report directly to the Central Station using the digital communicator's Point ID feature. If a sensor triggers an alarm or experiences supervisory trouble, a unique report code can be sent for immediate identification of the event.

The optional Model VB-2 digital voice response module can be installed in the Control Panel. The VB-2 module provides three exciting features: 2-way audio monitoring capability at the Central Station through the communicator, local voice prompts from the keypad's speaker (with Model RSM-2 speaker/microphone kit installed), and voice prompted remote system control using in-house or off-site pushbutton telephones.

The system has 24-hour capabilities that are always ready to operate, even when the system is disarmed. They can be triggered by buttons on the hardwired keypads, a wireless keypad, portable remote controls, carbon monoxide detectors, and smoke detectors. Pressing the **EMERGENCY** or **FIRE** button for two seconds will cause an immediate siren and call the central station. **IMPORTANT: For personal emergency use only. Not for use as a UL Listed Medical Alert System.**

The Control Panel's Environmental feature is active 24-hours and can be triggered with sensors connected to devices such as water flow detectors, over/under temperature sensors, flood sensors, etc. The Environmental feature activates the chime annunciator without sounding the siren. The Environmental feature does not send communicator reports.

An Automation Output in the Control Panel provides an easy way to connect external devices to the Control Panel. The output is fully programmable to activate on a variety of conditions, such as when the system is armed, during alarms, and during exit/entry delays. The Automation Output can connect to lighting control modules, relays, noisemakers, and indicators. The Control Panel's and wireless keypad's **(A)** key and any system sensors can control the Automation Output.

The Control Panel can be programmed locally using its own keypad or remotely, over the telephone, using Lineair's Model RA-2400 Remote Access software program. The RA-2400 upload/download program is a Windows™ application that runs on a personal computer and communicates with the Control Panel through a modem, connected directly to the panel, or through the telephone line.

DOOR/WINDOW SENSORS

The DXS-31 and DXS-32 sensors monitor doors and windows. They send radio signals to the Control Panel. One type of signal is sent when the door or window is opened, and a different type of signal is sent when the door or window is closed. If the system is armed, a sensor can trigger the Control Panel's burglary siren when its door or window is opened. Both sensors are supervised, send hourly status reports, and monitor their battery condition.

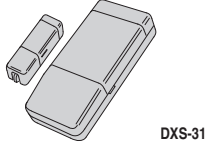

DXS-31

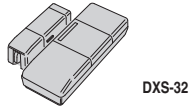

DXS-32

WIRELESS KEYPAD

The DXS-10 wireless keypad is used to operate the system remotely. It can be placed in a convenient spot so the user doesn't have to go to the hardwired keypad to operate the system. The wireless keypad can also trigger the emergency or fire siren and actuate the Automation Output. Pressing ***** will cause the hardwired keypad(s) to sound Beeps corresponding to the current operating mode. The DXS-10 is supervised, it sends hourly status reports and monitors its battery condition. **IMPORTANT: For personal emergency use only. Not for use as a UL Listed Medical Alert System.**



DXS-10

SMOKE DETECTOR

The DXS-73 is a high quality smoke detector with a built-in radio transmitter. As soon as smoke is detected, the unit will sound its local noisemaker. Then, 20 seconds after the local noisemaker sounds, the transmitter sends an alarm signal to the Control Panel. The alarm signal will be repeated every 20 seconds as long as smoke is still present. A restoral signal will be sent when the smoke detection chamber clears. The DXS-73 is supervised, it sends hourly status reports, and monitors its battery condition.

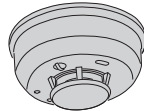

DXS-73

NOTE: A Model DXS-73 Smoke Detector is required to create a UL Listed smoke alarm system. See Page 26 for details on adding a smoke detector sensor to the system.

REMOTE CONTROLS

The DXT-41, DXT-61 single-button and DXT-23, DXT-42 multi-button remote controls can be used to remotely arm and disarm the system. The DXT-42's left button will arm and the right button will disarm the system. Pressing both buttons simultaneously will trigger the emergency siren. Alternately the Control Panel can be programmed to respond to the DXT-42 by arming and disarming with the left button, and activating the automation output with the right button. These transmitters can also be programmed to activate various other Control Panel zones. These transmitters are **not** supervised.

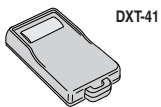

DXT-41

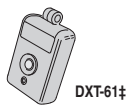

DXT-61‡



DXT-42

GLASS BREAK DETECTOR

The DXS-91 is a glass break detector with an audio sound discriminator and a built-in radio transmitter. The unit "listens" for the sound of breaking glass. When glass breakage is detected, the unit sends an alarm signal to the Control Panel. The DXS-91 is supervised, it sends hourly status reports and monitors its battery condition.

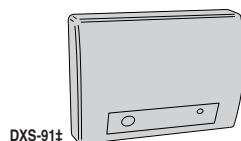

DXS-91‡

PANIC BUTTONS

The DXT-21, DXS-21 single-button, and DXT-23, DXS-23 two-button transmitters can be used as portable "panic buttons". Pressing the front or top button on the DXT-21 or DXS-21 at any time will trigger the emergency siren. Pressing **both** front buttons **simultaneously** on the DXT-23 or DXS-23 at any time will trigger the emergency siren. These transmitters can be programmed to activate various other system functions. The DXT-21 and DXT-23 transmitters are **not** supervised. The DXS-21 and DXS-23 transmitters **are** supervised. The DXS-62A transmitter is typically used as a portable "panic button". Pressing the button on a DXS-62A at any time will trigger the emergency siren. This transmitter can send hourly status signals and low battery signals if the battery is low.

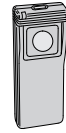

DXT-21‡

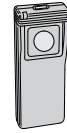

DXS-21‡



DXT-23‡

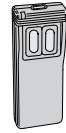

DXS-23‡



DXS-62A

BILL TRAP

The DXS-81 bill trap can be used with the Control Panel in non-UL small commercial hold-up installations. The unit is concealed in a cash drawer under a stack of currency, with a single "bait" bill secured in its money clip. During a hold-up, the cashier removes the stack of currency along with the "bait" bill. When a "bait" bill is removed, the transmitter sends a signal to the Control Panel. Four additional signals are sent within the first minute after the "bait" bill is removed. When the "bait" bill is replaced, a restore signal is sent. The DXS-81 is supervised, it can send hourly status reports (optional) and monitors its battery condition.

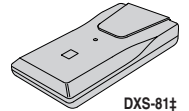

DXS-81‡

PASSIVE INFRARED MOTION DETECTOR

The DXS-54 is a passive infrared (PIR) motion detector with a built-in radio transmitter. The PIR detects motion in its detection pattern by measuring the infrared emission levels of objects that it "sees". If the infrared levels change quickly, as when a person moves across the detection pattern, the PIR will recognize the change as an intrusion and send an alarm signal to the Control Panel. An alarm will be triggered if the system is in the Away Mode. The DXS-54 is supervised, it sends hourly status reports and monitors its battery condition.

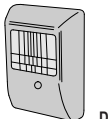

DXS-54

‡ NOTE: These accessories **not** listed by UL

2. SECURITY SYSTEM FLOOR PLAN

EXAMPLE SYSTEM

- ◆ The example shows a typical DUAL 824 system.
- ◆ Any or all of the accessories shown can be used.
- ◆ A total of 24 sensors can be used with each Control Panel. Each wireless sensor, hardwired loop, and wireless keypad used occupies a sensor location.

DESIGN THE INSTALLATION

1. Draw a floor plan for the installation.
2. Consider the security needs of the premises.
3. Determine which doors and windows are vulnerable to intrusion.
4. Figure which interior areas an intruder might go to if unlawful entrance is gained.
5. Indicate locations for door/window sensors, interior motion detectors, wireless and hardwired keypads, glass break detectors and external siren speakers.
6. Decide on a centralized location for the security Control Panel.

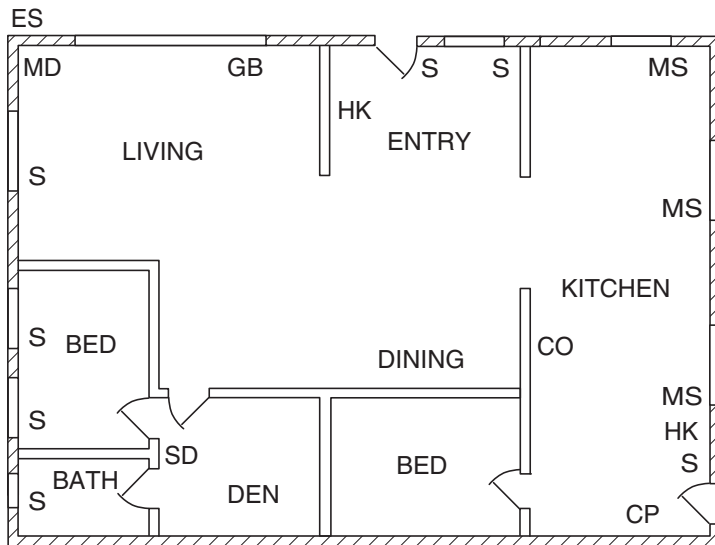

CP - CONTROL PANEL
 HK - HARDWIRED KEYPAD
 S - DOOR/WINDOW SENSOR
 WK - WIRELESS KEYPAD
 MD - MOTION DETECTOR
 ES - EXTERNAL SIREN
 SD - SMOKE DETECTOR
 CO - CARBON MONOXIDE DETECTOR
 GB - GLASS BREAK SENSOR
 MS - HARDWIRED MAGNETIC SWITCH

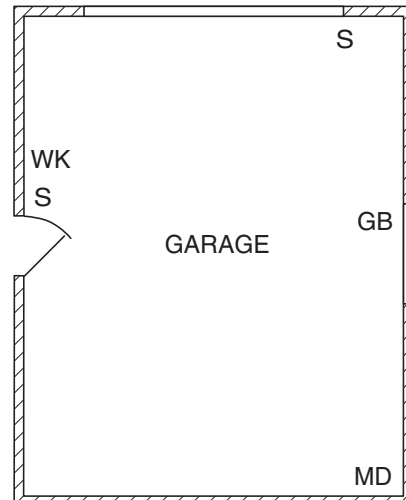

NOTE: IN NEW CONSTRUCTION, NFPA 72 REQUIRES A SMOKE DETECTOR LOCATED *INSIDE* EACH BEDROOM AS WELL AS A SMOKE DETECTOR ON EACH LEVEL.

Example Residential Security System Floor Plan

3. OVERVIEW OF KEYPADS

HARDWIRED KEYPAD

- ◆ One or two hardwired keypads can be used for controlling the system.
 - ◆ Three system status indicators: **READY, ARMED, & TROUBLE**
 - ◆ Three system supervisory indicators: **POWER, BATTERIES, & RADIO**
 - ◆ Five system mode indicators: **OFF, CHIME, HOME, AWAY & TEST**
 - ◆ 24 system sensor indicators.
 - ◆ Location inside beauty cover for supplied sensor identification labels.
 - ◆ Press **A** to activate the automation output.
 - ◆ Pressing ***** clears the keypad.
 - ◆ Pressing ***** for two seconds sounds the mode Beeps from the hardwired keypad(s).
 - ✓ Off Mode: 1 “Gong”.
 - ✓ Chime Mode: 1 “Gong” & 1 “Beep”.
 - ✓ Home Mode: 1 “Gong” & 2 “Beeps”.
 - ✓ Away Mode: 1 “Gong” & 3 “Beeps”.
 - ✓ Test Mode: 1 “Gong” & 4 “Beeps”.
 - ◆ Emergency and fire alarm can be triggered from the keypad at any time.
- UL NOTE: For personal emergency use only. Not for use as a UL Listed Medical Alert System.**

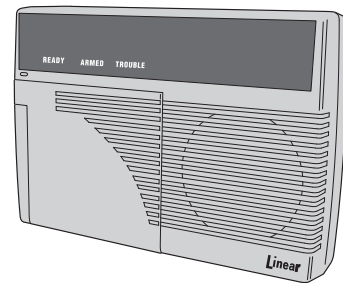

HARDWIRED KEYPAD

WIRELESS KEYPAD

- ◆ For controlling the system remotely.
 - ◆ Green operation light.
 - ◆ Internal 9-volt battery is monitored by the Control Panel.
 - ◆ Keypad's beeper will buzz during transmissions when the battery is low.
 - ◆ Up to 3 years battery life (depends on frequency of activation). (UL tested for 1 year minimum.)
 - ◆ Sends hourly status reports to the Control Panel.
 - ◆ Press **A** to activate the automation output.
 - ◆ Pressing ***** clears the keypad.
 - ◆ Pressing ***** for two seconds sounds the mode Beeps from the hardwired keypad(s).
 - ✓ Off Mode: 1 “Gong”.
 - ✓ Chime Mode: 1 “Gong” & 1 “Beep”.
 - ✓ Home Mode: 1 “Gong” & 2 “Beeps”.
 - ✓ Away Mode: 1 “Gong” & 3 “Beeps”.
 - ✓ Test Mode: 1 “Gong” & 4 “Beeps”.
 - ◆ Emergency and fire alarm can be triggered from the wireless keypad at any time.
- UL NOTE: For personal emergency use only. Not for use as a UL Listed Medical Alert System.**

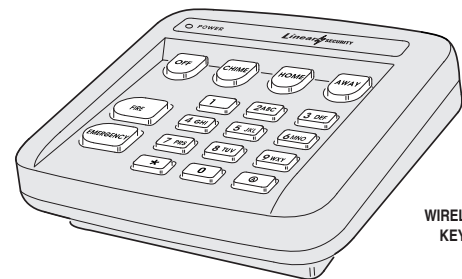

WIRELESS KEYPAD

ABOUT SENSOR STATUS SUPERVISION

All DXS Format sensors transmit hourly status reports. All DXT Format sensors do not transmit hourly status reports. Both sensor formats can be used with the system.

When a sensor is programmed into the Control Panel, the system will set the sensor as non-supervised or supervised. Sensors set as non-supervised are not expected to send hourly status reports. Sensors set as supervised are expected to send hourly status reports. If a status report is not received in 8 hours from a sensor set as supervised, the **RADIO** indicator will flash.

When sensors are programmed into the Control Panel, **ALL STATIONARY SENSORS ARE SET AS SUPERVISED, ALL PORTABLE SENSORS ARE SET AS NON-SUPERVISED.**

If stationary DXT Format sensors have been programmed into the Control Panel, be sure to change their setting to non-supervised to prevent **RADIO** indications. This will not prevent low battery monitoring.

If portable DXS Format sensors have been programmed into the Control Panel, and the installation requires supervision for specific portable sensor(s), change the selected portable sensors setting to supervised.

After programming the sensors, if changes are required, refer to “Changing a Sensors Supervision” on Page 30 for details on changing the way a sensor’s supervision is set.

4. HARDWIRED KEYPAD FEATURES

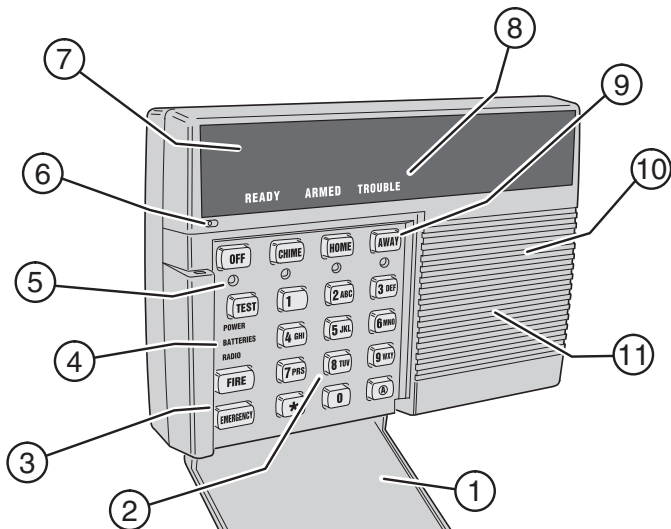

1 BEAUTY COVER

- ★ The beauty cover snaps open and shut to hide the keypad's keys, mode and supervisory indicators, and the sensor location labeling area.

2 KEYPAD

- ★ Backlit keys for easy viewing in low light conditions.
- ★ For entering the user's user code (numerically or alphabetically).
- ★ Used when programming system options.
- ★ Press **⓪** to activate the Automation Output.
- ★ Press **★** to clear keypad if the wrong key is pressed.
- ★ Press **★** for two seconds to view sensor battery and supervisory status (see **BATTERIES** and **RADIO** indicator description).

3 24-HOUR BUTTONS

- ★ Pressing **FIRE** for two seconds sounds the fire siren and sends a "fire" message to a central monitoring station through the digital communicator (if the system is monitored).
- ★ Pressing **EMERGENCY** for two seconds sounds the emergency siren and sends an "emergency" message to a central monitoring station through the digital communicator (if the system is monitored).
- ★ Both work even when system is disarmed.
- ★ **IMPORTANT: For personal emergency use only. Not for use as a UL Listed Medical Alert System.**

4 SYSTEM SUPERVISORY INDICATORS

- ★ Shows the current status of the system.

POWER LIGHT

- ★ Glows when AC power is on.
- ★ Blinks when AC power is off and backup battery is installed.
- ★ Blinks when the backup battery is low, recharging or missing.
- ★ Off when AC power is off and no backup battery is installed (system disabled).

BATTERIES LIGHT

- ★ Blinks when one or more sensors have a low battery.
- ★ Press **★** for two seconds to view sensor status. Sensor status indicator for any sensor with a low battery will light along with the **BATTERIES** indicator.
- ★ Switch to Test Mode after replacing the sensor battery and completely test the system (see Test Mode). Switching to Test Mode clears the low battery indication.

RADIO LIGHT

- ★ Blinks when one or more sensors have not reported status during the eight hour status time period.
- ★ Press **★** for two seconds to view sensor status. Sensor status indicator for any sensor that has not reported in will light along with the **TROUBLE** indicator.
- ★ Switch to Test Mode after servicing the sensor and completely test the system (see Test Mode). Switching to Test Mode clears the trouble indication.

5 MODE INDICATORS

- ★ The indicators next to the mode keys light to show the current system mode.
- ★ **HOME** indicator will blink during Secure Exit and Home Instant modes.
- ★ **AWAY** indicator will blink during the exit delay in the Away Mode.

6 MICROPHONE (OPTIONAL)

- ★ Location for the high sensitivity microphone included with the Model RSM-2 speaker/microphone kit.
- ★ Detects room audio when communicator is reporting to the Central Station in 2-way audio mode (Model VB-2 digital voice response module and RSM-2 speaker/microphone kit must be installed).

7 SENSOR STATUS INDICATORS

- ★ Blacked-out sensor status indicators are only visible when lit.
- ★ Indicate the status of each of the system's wireless sensors and hardwired loops.
- ★ Indicators show which doors and windows are open.
- ★ Indicators flash to display sensors that have caused an alarm.
- ★ Stick-on labels are provided to identify the custom sensor locations.

8 SYSTEM STATUS INDICATORS

- ★ Shows the current status of the system.

READY LIGHT

- ★ Lights when all system sensors are closed.
- ★ Shows that the system is ready to be armed.
- ★ The system can be armed without the **READY** indicator being lit, if sensors are bypassed either manually or automatically.

ARMED LIGHT

- ★ Blinks during the exit delay.
- ★ Lights when the system is fully armed.

TROUBLE LIGHT

- ★ Lights when the system has detected supervisory trouble.
- ★ Supervisory trouble can be caused by power, sensor low battery, or sensor radio supervision conditions.
- ★ Press **★** for one second then view the system supervisory and status indicators to determine the origin of the trouble.

9 MODE BUTTONS

- ★ Used to operate the system.

OFF

- ★ Off Mode disarms the system.
- ★ **Switching to Off Mode stops the alarm siren.**
- ✓ Multiple Beeps sound and sensor status indicators flash if an alarm has occurred.
- ☞ **Multiple Beeps mean caution. AN INTRUDER MAY STILL BE PRESENT.**

CHIME

- ★ Chime Mode disarms the system.
- ★ **Switching to Chime Mode stops the alarm siren.**
- ✓ Multiple Beeps sound and sensor status indicators flash if an alarm has occurred.
- ☞ **Multiple Beeps mean caution. AN INTRUDER MAY STILL BE PRESENT.**
- ★ Chime Mode is for monitoring doors and windows.
- ✓ Use this mode as an "automatic door chime" when at home.
- ✓ Opening any protected door or window causes the keypad(s) to "ding-dong".

HOME

- ★ Home Mode arms the perimeter sensors, but not the interior sensors.
- ✓ Use this mode when anyone is staying behind.
- ✓ Interior motion detectors and interior door sensors are not armed.
- ✓ Home secure mode makes all delayed perimeter sensors instant.
- ✓ Secure exit mode starts an exit delay while remaining in Home Mode.
- ✓ Re-entering during the exit delay restarts the exit delay (one time only).

AWAY

- ★ Away Mode arms the entire system.
- ✓ Use this mode when leaving home.
- ✓ Door sensors set for delayed will have a time delay that allows the user to leave and enter the premises without sounding the alarm.
- ✓ Re-entering during the exit delay restarts the exit delay (one time only).
- ✓ Entry Delay Beeps warn the user to disarm the system before the siren starts.

TEST

- ★ Test Mode is for testing the system sensors.
- ✓ All sensor status lights blink when the Test Mode is entered.
- ✓ Each sensor status light will stop blinking when its sensor is tested.
- ★ Hold the **TEST** button down to test all of the keypad's indicator lights.

10 SOUNDER

- ★ Makes unique sounds for burglary, fire and emergencies.
- ★ Alarm sirens stop automatically after five minutes.
- ★ Sounds advisory tones to confirm keystrokes from the keypad.
- ★ Sounds mode selection tones.
- ★ Sounds alarm memory tones.
- ★ Beeps when Automation Output is activated.
- ★ The Control Panel has terminals available for an external siren.

11 SPEAKER (OPTIONAL)

- ★ Location for the speaker included with the Model RSM-2 speaker/microphone kit.
- ★ Sounds voice operating prompts and audio from the Central Station (Model VB-2 digital voice response module and Model RSM-2 required).

5. CONTROL PANEL FEATURES

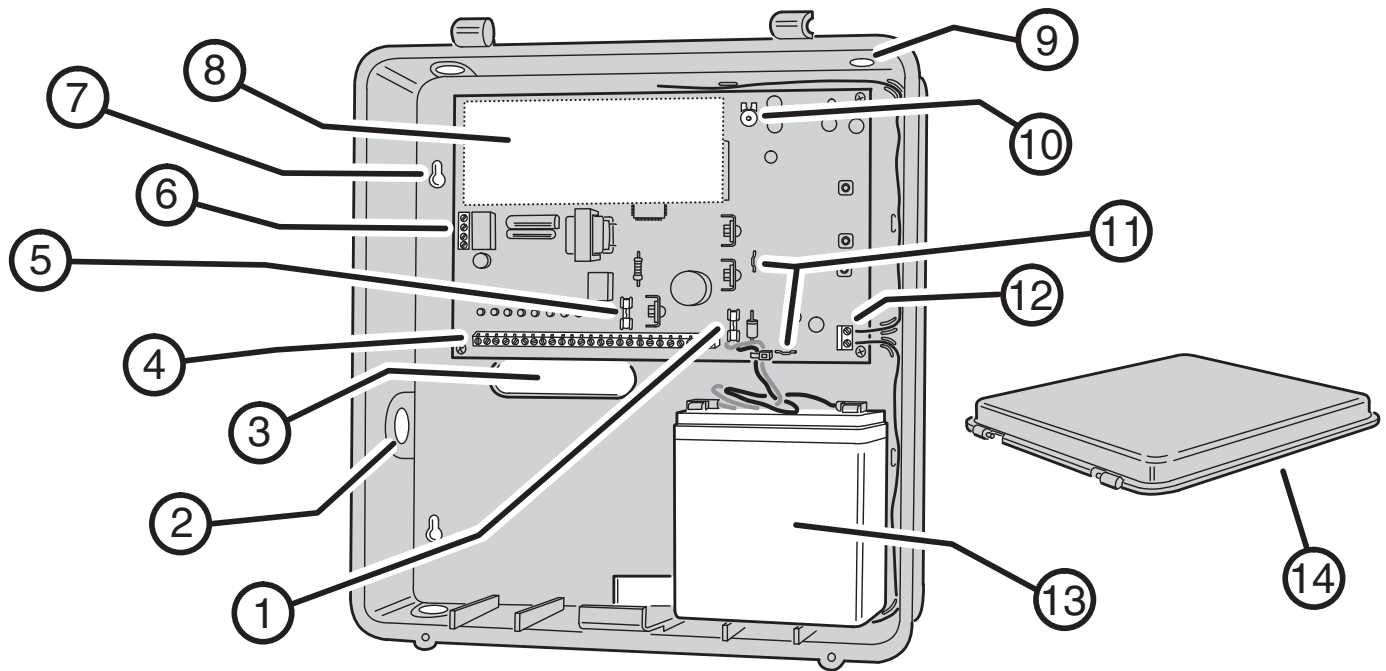

1 BATTERY FUSE

- ★ Type 2AG, 3-amp fuse for the backup battery.
- ★ If the keypad's **POWER** light is flashing and the optional backup battery is installed and charged, check this fuse.
- ⚠ **WARNING: For continued protection against the risk of fire, replace only with the same type and rating of fuse.**

2 CONDUIT KNOCKOUTS

- ★ Four cabinet knockouts are provided for wiring using conduit.
- ★ The 3/4" knockouts fit standard 3/4" conduit fittings.

3 WIRING ACCESS SLOT

- ★ Provides access for wiring through a hole in the mounting wall.
- ★ Route cables for power, telephone, external speaker, etc. through this slot.

4 MAIN TERMINAL BLOCK

- ★ Terminals for hardwired loop inputs.
- ★ Terminals for Automation Output to connect to an automation controller.
- ★ Terminals for external relay output for "dry" contacts (Form C, normally open/ normally closed, 1 amp @ 24 volts maximum).
- ★ Terminals for fused auxiliary 12 volt output and common ground.
- ★ Terminals for connection to one or two Model DUAL 824KP keypads.
- ★ Terminals for connection to the plug-in AC transformer.

5 AUXILIARY FUSE

- ★ Type 2AG, 1-amp fuse.
- ★ Protects the auxiliary power output and siren driver circuit.
- ★ Fuse will blow when load exceeds 1 amp total.
- ⚠ **WARNING: For continued protection against the risk of fire, replace only with the same type and rating of fuse.**

6 TELEPHONE TERMINAL BLOCK

- ★ Provides telephone connections for the digital communicator.
- ★ Provides telephone connection for voice prompted telephone remote control (optional VB-2 digital voice response module required).
- ★ Provides seized ring and tip connections for local telephone instruments. Communicator will disconnect local telephones while on-line.

7 WALL-MOUNT KEYHOLE SLOTS

- ★ Four slots used when mounting Control Panel to the wall.
- ★ Used as a template for the Control Panel when it is mounted to the wall.

8 DIGITAL VOICE RESPONSE MODULE (OPTIONAL)

- ★ The Model VB-2 gives the Control Panel's digital communicator listen-only, manual 2-way and full duplex 2-way audio capability with the Central Station.
- ★ The module allows remote command of the system using a standard pushbutton telephone, on or off site.
- ★ The module provides optional voice prompts from the keypad(s) (Model RSM-2 speaker/microphone kit required for each keypad).

9 ANTENNA KNOCKOUT

- ★ A cabinet knockout is provided for mounting an external antenna connector.
- ★ For an external antenna, use Linear's Model LA-P antenna kit.
- ★ The antenna kit can also be used to connect the Control Panel to co-ax for a remote antenna.

10 ANNUNCIATOR VOLUME CONTROL

- ★ Varies the volume of the advisory tones that come from the keypad(s) speaker when the Model RSM-2 speaker/microphone kit is installed in the keypad.
- ★ Does **not** affect keypad's sirens (they are always full volume).

11 RADIO TEST POINTS

- ★ Used to monitor the Control Panel's radio receiver during troubleshooting.
- ★ Provides connection for an audio amplifier to listen to the receiver's output.
- ★ Helpful to determine sources of radio interference.

12 ANTENNA TERMINALS

- ★ Antenna and shield (ground) terminals for receiving signals from the system's sensors.
- ★ Pre-wired to the Control Panel's internal wire dipole antenna.
- ★ Alternately connects to the Model LA-P local whip and remote antenna kit.

13 OPTIONAL BACKUP BATTERY

- ★ Space for 12-volt, 4 amp/hour backup battery. (Highly recommended.)
- ★ Backup battery is automatically charged and monitored by the Control Panel.
- ★ Backup battery can power the Control Panel for up to 6 hours.
- ★ **UL NOTE: Normal estimated battery life should be 3 to 4 years.**

14 REMOVABLE CABINET COVER

- ★ The cabinet cover can be removed for easy system wiring and setup.
- ★ Two screws secure cabinet cover when closed.
- ★ An optional cabinet lock can be installed for additional security.

6. CONTROL PANEL INSTALLATION

SYSTEM LOCATION

- 🔧 **NOTE: Wireless sensor signals must be able to reach the Control Panel.**
 - ✓ Try to centrally locate the Control Panel.
 - ✓ Keep Control Panel away from large metal appliances.
 - ✓ Maximum recommended sensor range is 400 feet (system tested at 1000 feet).
 - 🔧 **NOTE: If you don't use the wireless keypad, a hardwired keypad should be easily accessible to the usual entrance.**
 - ✓ When the Control Panel is set in the Away Mode, the user has 30 seconds to switch to Off Mode before the burglary siren sounds.
 - 🔧 **NOTE: Make sure a hardwired keypad is in a place where the alarm can be heard during the night hours.**
 - ✓ Optional remote external sirens (up to 150 feet from the Control Panel) can be used to make alarms louder and remote the sound location.
1. Locate the Control Panel near a 115 VAC outlet that's not controlled by a light switch.
 2. Locate the Control Panel near a telephone outlet (if using the digital communicator).

WALL MOUNTING

1. Use the Control Panel's case bottom as a template and mark the locations for the four mounting screws.
2. Mark the wiring access slot if the wiring is being routed from behind the cabinet.
3. Use a hole saw to cut out the location for the wiring access slot (if used) or punch out selected cabinet wiring knockouts for conduit wiring.
4. Use four screws and appropriate screw anchors to mount the unit to the wall.

EXTERNAL ANTENNA

- ◆ Linear's Model LA-P antenna kit can be used with the DUAL 824P Control Panel to replace the standard internal antenna.
 - ◆ The antenna can be mounted on the cabinet, or the kit can be used to connect to co-ax for a remote antenna.
1. Remove the two standard white antenna wires attached to the **ANT** and **SHIELD** terminals.
 2. Punch out the antenna knockout.
 3. Mount the antenna connector in the antenna knockout.
 4. Route the antenna co-ax down to the Control Panel's antenna connector.
 5. Connect the antenna's co-ax center conductor to the **ANT** terminal.
 6. Connect the antenna's co-ax shield to the **SHIELD** terminal.
 7. Route the two antenna ground wires as shown.

USE THE CASE BOTTOM AS A TEMPLATE TO MARK THE FOUR KEYHOLE MOUNTING HOLES

FOR RECESSED WIRING, MARK WIRING SLOT, THEN CUT OUT HOLE WITH DRYWALL SAW

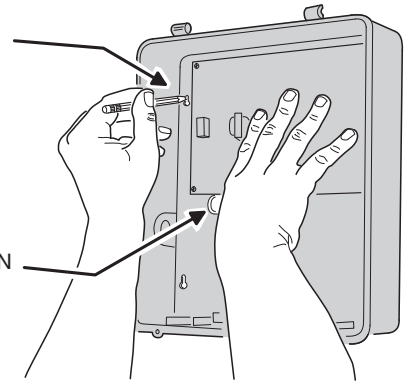

FOR CONDUIT WIRING, PUNCH OUT REQUIRED KNOCKOUTS AND INSTALL 3/4" CONDUIT HUBS IN HOLES

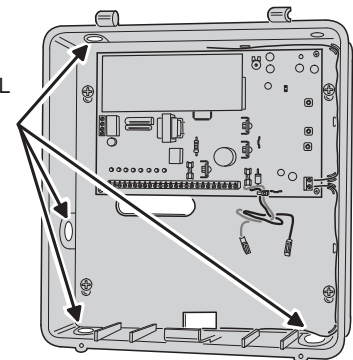
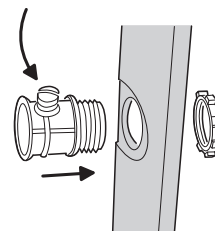

① PUNCH OUT ANTENNA KNOCKOUT AND INSTALL LA-P ANTENNA CONNECTOR INTO HOLE

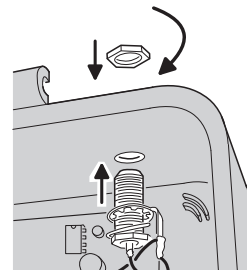

② CONNECT CO-AX SHIELD TO SHIELD TERMINAL AND CO-AX CENTER CONDUCTOR TO ANT TERMINAL

③ INSTALL THE WHIP ANTENNA AND ROUTE THE TWO GROUND WIRES AS SHOWN

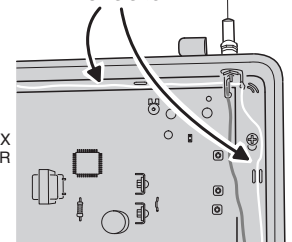

HARDWIRED KEYPAD INSTALLATION

- ◆ One or two Model DUAL 824KP keypads can be used with the DUAL 824P Control Panel (one keypad is included in the DUAL 824 system package).
 - ◆ The keypad is supplied with a short wiring harness and connector.
1. Use a flat blade screwdriver to open the keypad case. Identify the keypad internal components.
 2. Set the keypad select jumper to **KEYPAD 1** if this is the first, or only, keypad installed. Set the jumper to **KEYPAD 2** if this is the second keypad installed.
 3. For a silent keypad, set the **SOUNDER** jumper to **OFF**.
 4. Select an indoor location with easy wiring access to the Control Panel and use the keypad's mounting plate as a template to mark the mounting holes for the keypad.
 5. Route 4-conductor 22 AWG (or larger) wire from the Control Panel to the keypad(s). Up to 100 feet of wire total can be used with this system. If installing two keypads, each keypad can be "home-run" or "daisy-chained".
- Note:** *If a Model VB-2 voice response module is going to be used with the system, in addition to the keypad's four wires, route 2-conductor shielded cable and 2-conductor 22 AWG wire from the Control Panel to the keypad(s) for the keypad's microphone and speaker. When using two keypads and two microphones, each shielded microphone cable must be home run to the VB-2 terminal block.*
6. If using the VB-2 voice response module, refer to the instructions supplied with the Model RSM-2 speaker/microphone kit for details on installing and wiring the keypad's speaker and/or microphone.
 7. Connect the 4-conductor wire to the Control Panel's keypad terminals, noting wire colors.
 8. Noting wire colors, connect the keypad's wiring harness to the wire from the Control Panel.
 9. Plug the keypad wiring harness into the keypad connector and snap the keypad case closed.

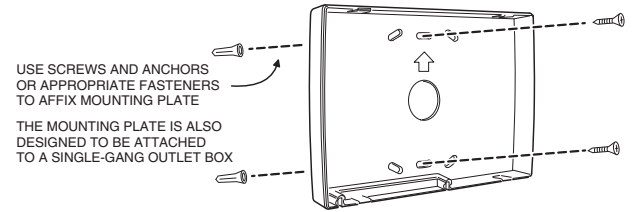
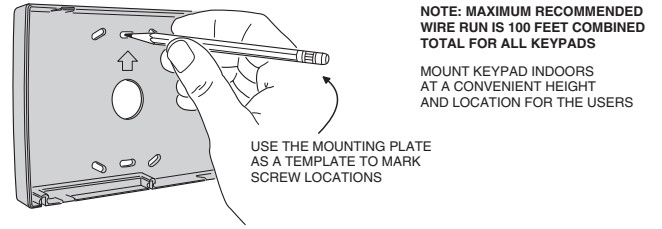
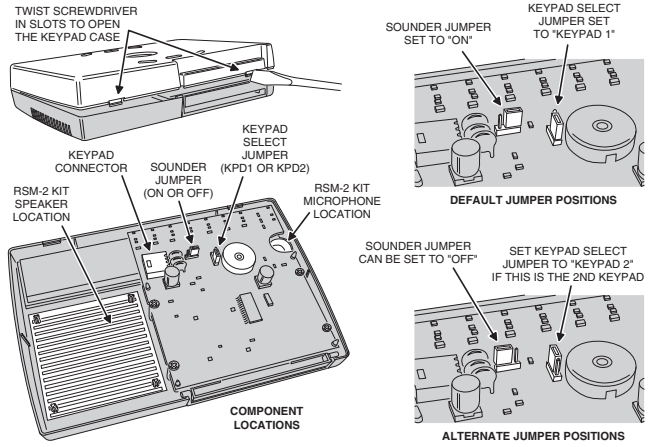

ROUTE 4-CONDUCTOR 22 AWG WIRE OR LARGER FROM CONTROL PANEL TO KEYPAD

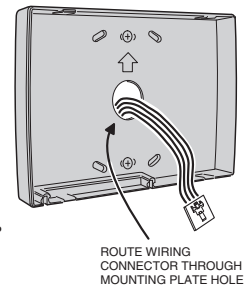
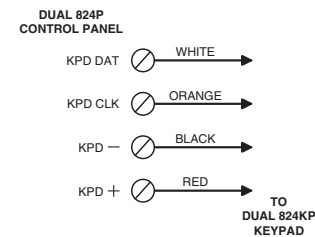

IF THE RSM-2 SPEAKER/MICROPHONE KIT IS GOING TO BE USED, RUN AN ADDITIONAL PAIR FOR THE SPEAKER AND A SHIELDED PAIR FOR THE MICROPHONE

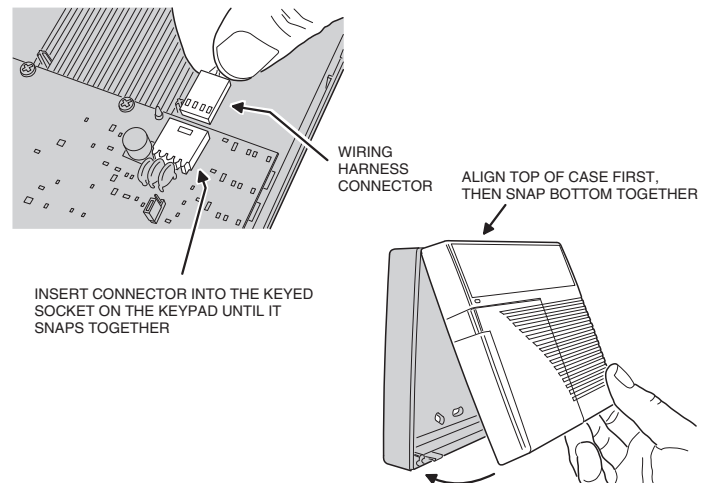

HARDWIRED LOOP WIRING

- ◆ The DUAL 824 supports up to eight normally open/closed hardwired loops each with 2.2K end-of-line resistor supervision.
- ◆ Each hardwired loop that is wired and programmed uses one sensor location.
- ◆ Each hardwired loop can be programmed to any sensor number.
- ◆ Each hardwired loop can be programmed as any sensor type, including arm/disarm toggle.
- ◆ Four COM terminals are shared as loop returns for the eight loops.
- ◆ Each hardwired loop has a 400 millisecond response time.

🔗 **NOTE: For UL installations, use UL Listed cable for all hardwired loop wiring.**

1. Route wiring from the Control Panel to each hardwired switch contact, sensor, or device. Route the wires through the wiring slot or through a knockout for conduit wiring.

🔗 **NOTE: Maximum recommended hardwired loop length is 500 feet (250' out, and 250' back) for each loop. Maximum loop resistance (excluding the EOL resistor) is 100 ohms.**

2. Connect the loop wires to LOOP # and COM terminals. For powered devices connect power wires to +12 VDC and any COM terminal.

3. On the sensor end, connect each normally closed sensor in series with the loop wires. Connect each normally open sensor in parallel with the loop wires. See wiring figure.

4. After the last sensor on the loop, connect a 2.2K end-of-line resistor across the loop.

🔗 **NOTE: Before the hardwired loops will function, they will need to be programmed. This will be covered in the Basic Control Panel Programming section of this manual.**

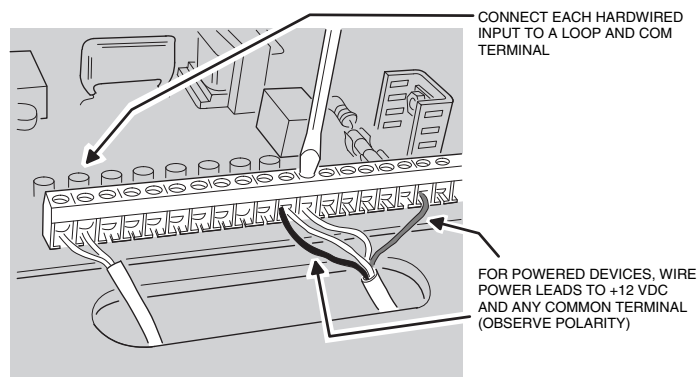
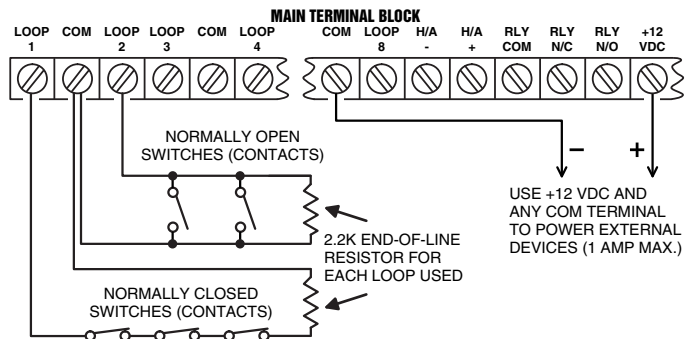
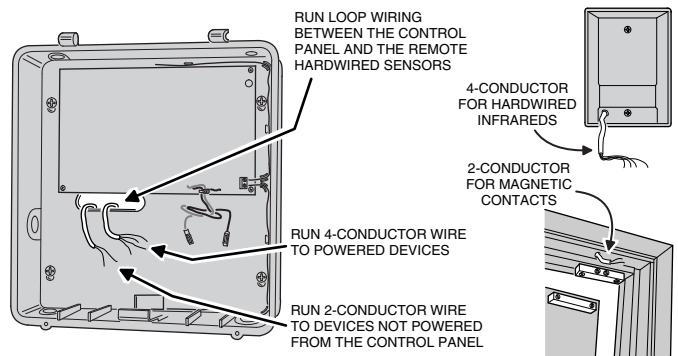

ARM/DISARM KEY STATION WIRING

- ◆ Any of the hardwired loops can be used with a momentary keyswitch to arm and disarm the system.

1. Connect the loop as shown to the keyswitch and end-of-line resistor.
2. Connect an LED indicator from the switch plate to the H/A- and H/A+ terminals.
3. When programming the system, set the loop sensor function to "Type 9, Arm/Disarm Toggle" and set the Automation output to "Active while Armed".

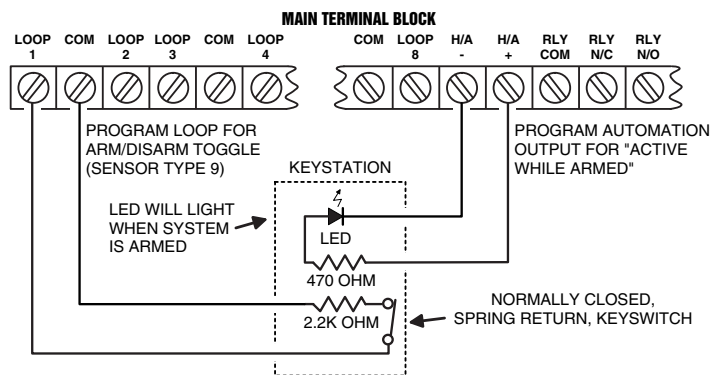

EXTERNAL ALARM SIREN CONNECTION

- ◆ An external siren alerts occupants and neighbors with a loud siren during alarm.
- ◆ Use a 12 volt, 1 amp maximum rated weather-resistant horn speaker with a built-in siren driver. Do not use a plain speaker without a siren driver.
- ✎ **NOTE: Connection of an electromechanical bell or motor bell is not recommended because of the radio interference generated when the bell is running.**

✎ **UL NOTE: Only one external siren is allowed in UL installations.**

1. Mount the external siren.
2. Route the wires from the external siren to the Control Panel.
3. Route the siren wires up through the wiring access slot or through a knockout when using conduit.
4. Connect a jumper wire from the +12 VDC terminal to the RLY COM terminal.
5. Connect the positive siren wire to the RELAY N/O terminal.
6. Connect the negative siren wire to one of the COM terminals.

✎ **NOTE: The relay contacts are isolated. Use the RLY N/O & RLY COM terminals alone to switch an externally powered load.**

TELEPHONE LINE CONNECTION

- ◆ Connect the Control Panel to the telephone line if the system is monitored, requires 2-way audio, telephone remote command, or for remote programming with RA-2400 software.
 - ◆ Telephone RING & TIP terminals are for connection to the incoming telephone line.
 - ◆ Seized telephone ring & tip (R1 & T1) are for connection to local telephone sets. When the communicator activates, all the local telephone sets will be disconnected to prevent an off-hook telephone on the premises from blocking the communicator call.
1. Install a USOC RJ31-X or RJ38-X jack to the telephone system near the Control Panel.
 2. Route an appropriate modular telephone line cord from the jack to the Control Panel.
 3. Route the line cord through the Control Panel's wiring access slot or through a knockout for conduit wiring.
 4. Connect the incoming telephone line wires to the Control Panel's telephone terminal block TIP and RING terminals.
 5. Connect the local telephone set wires to the Control Panel's telephone terminal block T1 and R1 terminals.
- ◆ When directly connecting (without a telephone line) to the DUAL 824 with the RA-2400 remote access software (Version 1.3 or later), disconnect the incoming telephone line and connect the modem to the panel's TIP and RING terminals (with the modem's red & green phone line wires). Press the **EMERGENCY** key while in Test Mode to cause the panel to connect to the modem.

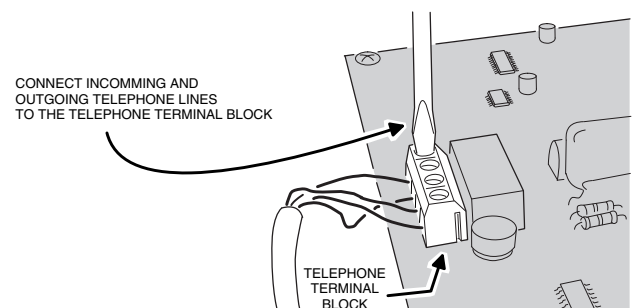
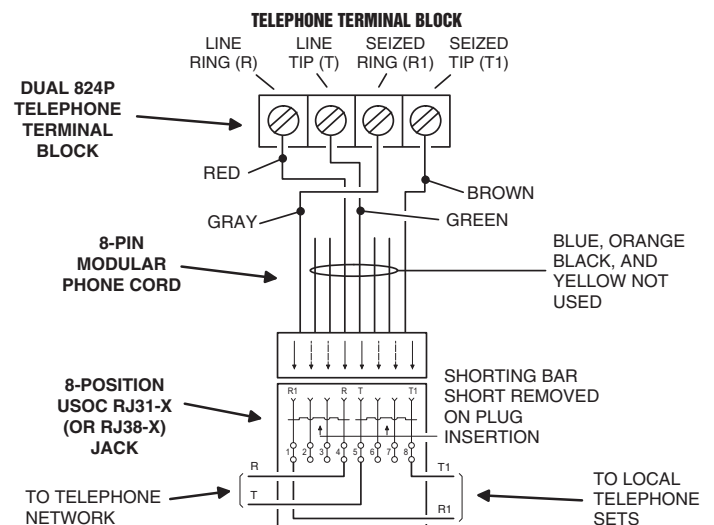
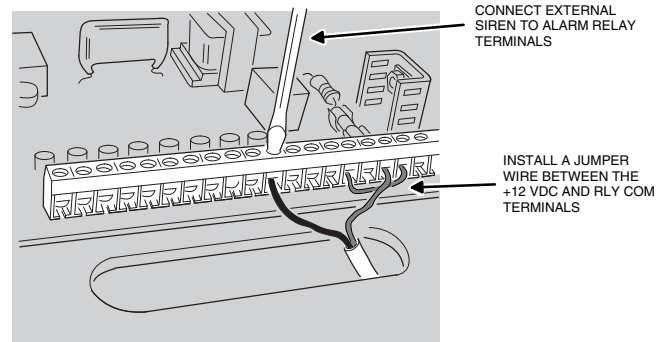
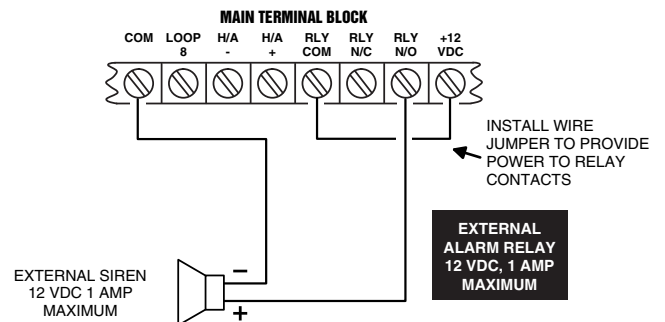
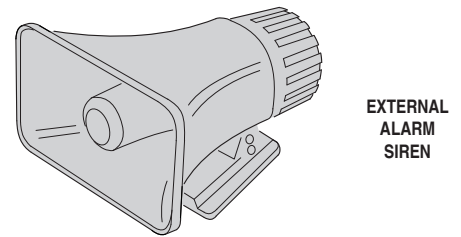

AUTOMATION OUTPUT CONNECTION

- ◆ The Control Panel provides a Automation Output to control lights, devices and appliances.
- ◆ Automation Output can connect to most popular home automation devices and other simple electronic devices (see figure).
- ◆ Press **(A)** to turn the Automation Output on, press **(A)** again to turn it off.

Programmable Options

- ◆ There are many programmable options for the Automation Output.
- ◆ The Automation Output can be programmed for a variety of useful functions, such as: flashing during alarm, flashing after an alarm, on while armed, or, on during exit/entry delays.
- ◆ See the “Advanced Programming” section of this manual for details on changing the function of the Automation Output.

VOICE RESPONSE MODULE

- ◆ The DUAL 824P circuit board has a plug-in location for a Model VB-2 voice response module.
- ◆ The VB-2 module allows remote command of the system locally and remotely through a pushbutton telephone.
- 📎 **NOTE: The following two features require a Model RSM-2 speaker/microphone kit installed in the keypad.**
- ◆ The VB-2 module can sound voice prompts through a speaker installed in the keypad.
- ◆ The VB-2 module supports listen-only audio, two-way manual audio, and full duplex two-way audio communication with the Central Station through a microphone installed in the keypad.
- 📎 **NOTE: Refer to the VB-2 instructions for details on operating the voice response module.**

Voice Response Module Installation

1. Identify the audio module components, noting the terminal block positions.
2. Connect shielded microphone wire to the VB-2 **MICROPHONE COMMON** (for shield) and **MICROPHONE #1** (for center conductor) terminals. Connect the other end of the wire's shield to the **BLACK**, and center conductor to the **RED** microphone wires in the keypad.
3. If using two keypads for audio monitoring, repeat Step 2 for the second keypad, except connect the center conductor to the VB-2 **MICROPHONE #2** terminal.
4. **WITHOUT POWER APPLIED TO THE CONTROL PANEL**, plug the voice response module into the sockets on the Control Panel's circuit board. Be sure the arrows on the module board are pointing up.
5. Connect 2-conductor wire from the Control Panel's **KPD SPK+** and **KPD SPK-** terminals to the two speaker wires in the keypad.

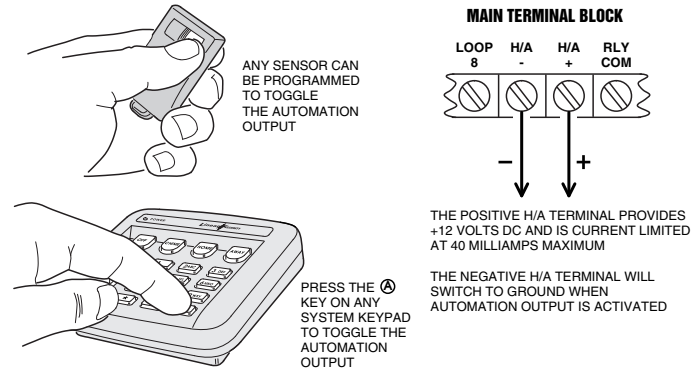

EXAMPLE AUTOMATION OUTPUT HOOK-UPS

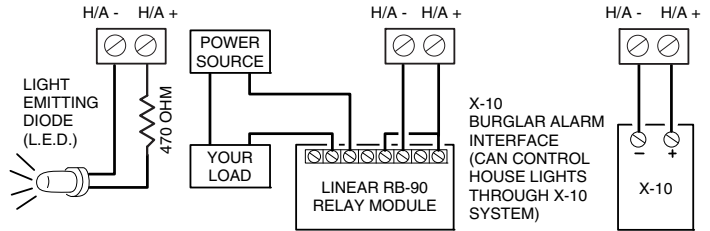

VB-2 VOICE RESPONSE MODULE

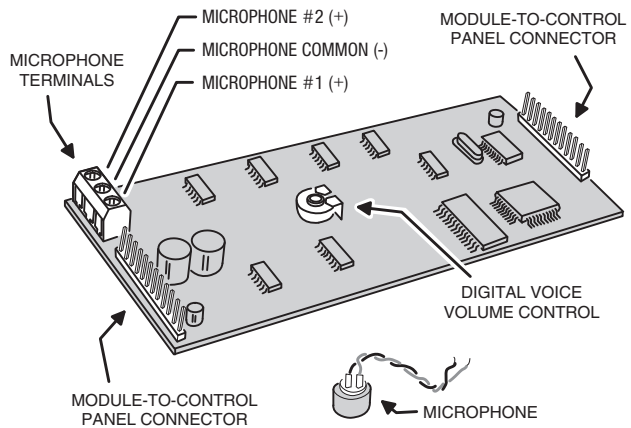

BE SURE CONTROL PANEL POWER IS DISCONNECTED!

CAREFULLY PLUG VOICE MODULE INTO THE TWO CIRCUIT BOARD SOCKETS

BE SURE ALL PINS ARE ALIGNED

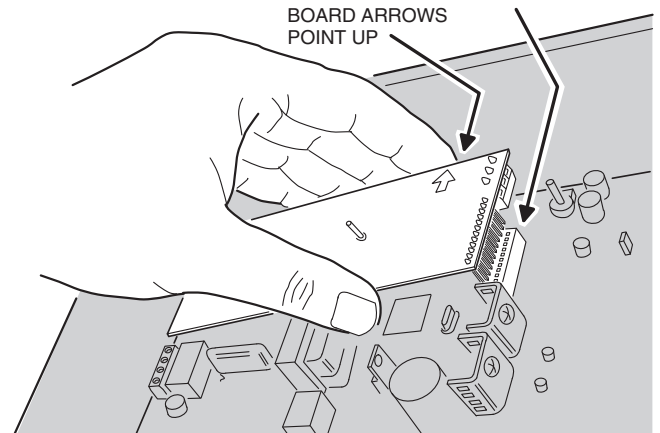

CONTROL PANEL POWER CONNECTION

- ◆ The Control Panel is powered by a low voltage plug-in transformer.
 - ◆ Use up to 25 feet of 20 AWG or larger 2-conductor wire to connect the transformer to the Control Panel.
1. Route the power wires from the plug-in transformer to the Control Panel.
 2. Connect the wires to the transformer terminals **(do not plug the transformer in until the wiring is complete)**.
 3. Route the power wires through the Control Panel's wiring access slot or through a knockout for conduit wiring.
 4. Connect the power wires from the transformer to the Control Panel's main terminal block **AC & AC** terminals.
 5. Plug transformer into an **unswitched AC** outlet.
 6. Secure transformer with screw to prevent unplugging.

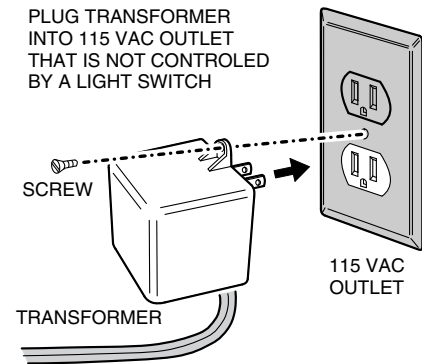
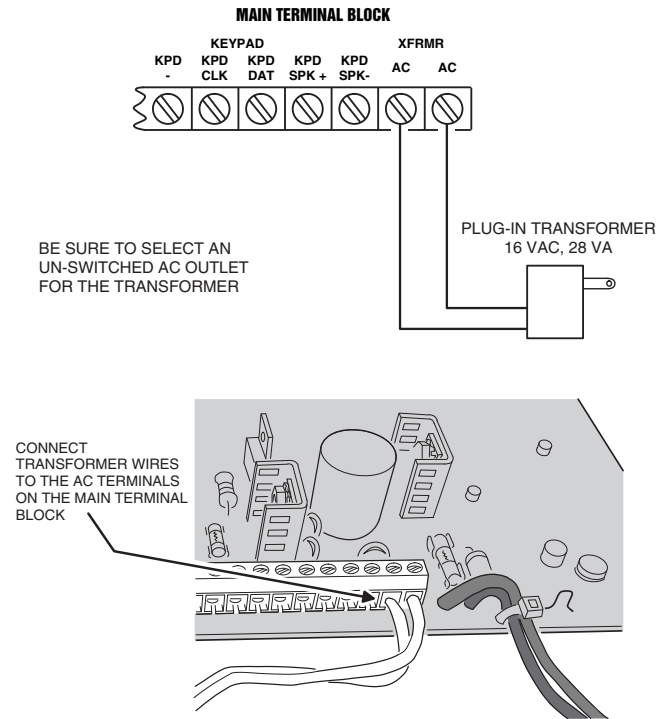

BACKUP BATTERY INSTALLATION

- ◆ A 12-volt backup battery may be installed and is highly recommended.
 - ◆ The backup battery will power the system for up to 6 hours during AC power loss.
 - ◆ The backup battery is automatically charged by the Control Panel when AC power is present.
 - ◆ A low backup battery will cause the keypad's **POWER** indicator to flash as it is being charged.
1. Position the battery as shown.
 2. Connect the black battery lead to the negative battery terminal.
 3. Connect the red battery lead to the positive battery terminal.
- ⚠ **WARNING: DO NOT REVERSE THE BATTERY LEADS! THE BATTERY FUSE WILL BLOW.**

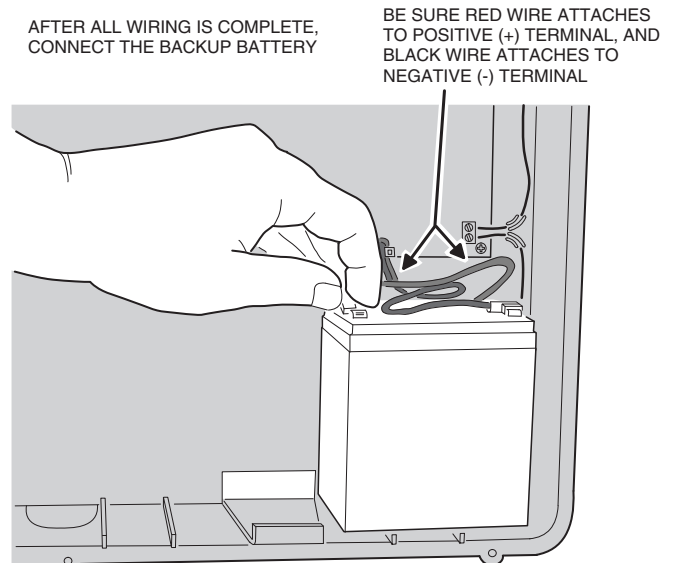

7. BASIC CONTROL PANEL PROGRAMMING

- ◆ In a new installation, when power is first applied the system's master user code is "1234".

CREATE THE MASTER USER CODE

📎 **NOTE:** Local programming must be entered on the system's hardwired keypad, not on a wireless keypad.

1. Press ***** (clears keypad if any other keys have been pressed).
2. Place the system in Test Mode (enter 1234 and press **TEST**).
 - * A "gong" and four "beeps" will sound.
3. Enter the Setup Mode **from Test Mode**, enter **1234** then press **TEST** again.
 - * A "gong" and five "beeps" will sound. The system is now in Test Mode.
4. Enter 99 then press **HOME**.
5. Enter any combination of 1-5 digits for the master user code, then press **AWAY**.
 - 📎 **NOTE:** For maximum security, a three to five digit code is recommended.
6. Press and hold the **OFF** key for 3 seconds to exit program mode.
7. Test the new master user code by entering it then pressing **TEST**.
8. Log the master user code in the box below.

MASTER USER CODE:

📎 **NOTE:** The master user code can be used to enter Setup Mode. The restricted user codes cannot. To create restricted user codes, see the "Advanced Programming" section of this manual.

ENTERING SETUP MODE

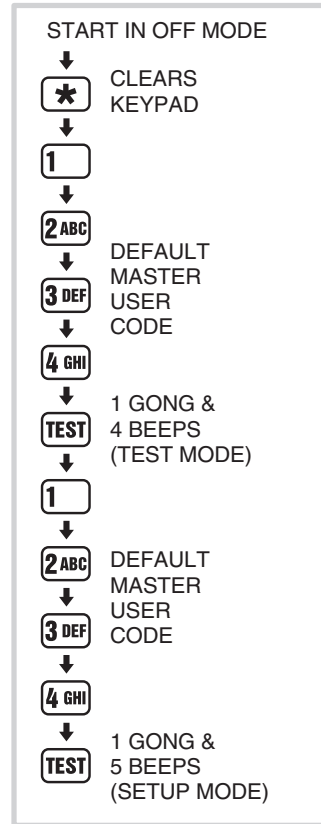

SETTING A NEW MASTER USER CODE

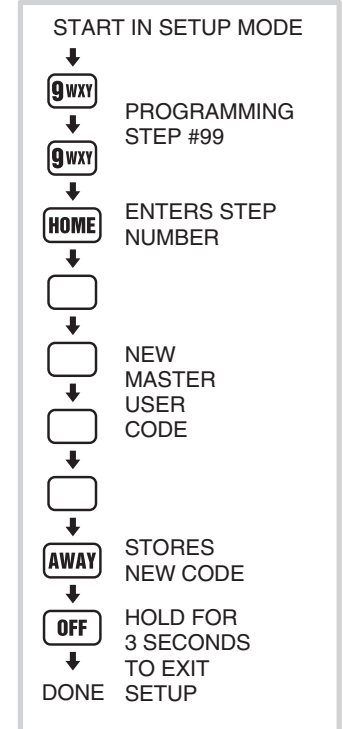

PROGRAM THE HARDWIRED LOOPS

- ◆ Each hardwired loop used must be programmed into the Control Panel's memory.
 - ◆ Each hardwired loop programmed uses one of the twenty four available sensor locations.
1. Start with the system in Test Mode (enter the master user code and press **TEST**).
 2. Enter the Setup Mode **from Test Mode**, enter the **master user code** then press **TEST** again.
 - * A "Gong" and five "Beeps" will sound. The system is now in Setup Mode.
 - * The sensor status indicators will light for any sensors already programmed into the Control Panel.
 3. Enter programming Step #301-308 (301=loop 1, 302=loop 2, etc.) for the hardwired loop desired.
 4. Press **HOME** to select step.
 5. Enter an unused sensor number from 01-24 for the loop (you must enter two digits, example: 5 = 05).
 6. Press **AWAY** to store.
 - * A single "Bing" tone will sound and the sensor status indicator for that sensor will stay lit. A double "Buzz" will sound if that sensor location is already in use.
 7. Repeat Steps 3-6 to enable all of the hardwired loops used.
-  **NOTE: The default sensor function for the hardwired loops is Perimeter (Type 5). Any sensor function can be selected for each hardwired loop, refer to the "Customizing the System" section of this manual.**

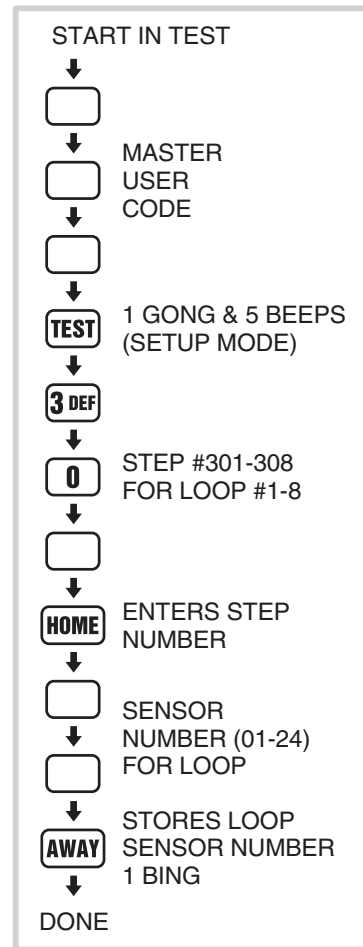

PROGRAM THE WIRELESS SENSORS

- ◆ Each wireless sensor used must be programmed into the system's memory. See the next two pages for details on activating different models of transmitters.
 - ◆ Each wireless sensor programmed uses one of the twenty four available sensor locations.
1. Start with the system in Test Mode (enter any user code and press **TEST**).
 2. Enter the Setup Mode **from Test Mode**, enter the **master user code** then press **TEST** again.
 - * A "Gong" and five "Beeps" will sound. The system is now in Setup Mode.
 - * The sensor status indicators will light for any sensors programmed into the Control Panel.
 3. Enter an unused sensor number from 01-24 (you must enter two digits, example: 5 = 05).
 - * The sensor indicator light will flash for the sensor number selected.
 4. Activate the sensor by sending a test or alarm signal (be sure the sensor's battery is connected or that its battery protection strip is removed).
 - * A single "Bing" tone will sound and the sensor status indicator for that sensor will stay lit. A "Buzz" will sound if that sensor location is already in use.
 5. Repeat Steps 3 & 4 for each additional sensor, or exit Setup Mode by pressing the **OFF** button for three seconds.

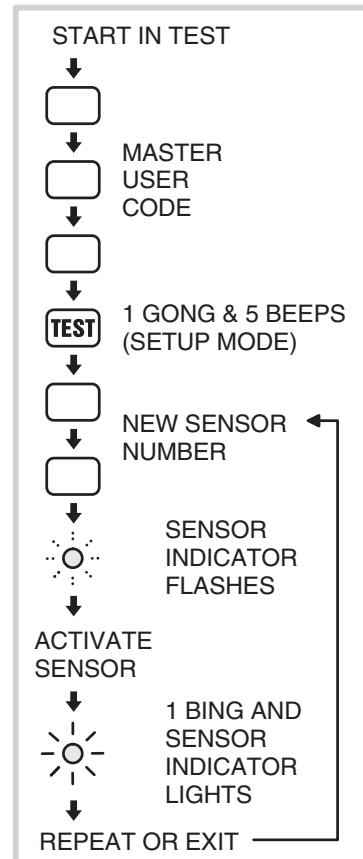

PROGRAMMING DIFFERENT SENSOR TYPES

- ◆ Follow the instructions on the previous page to select a sensor number to program the sensor into.
- 📎 **NOTE: A sensor can be programmed into more than one location. Be sure to choose an UNUSED sensor number. If a sensor gets entered into more than one location, delete the duplicates using the remove sensor function.**
- ◆ To add DXS-10 wireless keypads, press and hold the keypad's * key until programmed into the Control Panel.
- ◆ For DXS-31 and DXS-32 door/window sensors, move the magnet away from the side of the sensor.
- 📎 **IMPORTANT NOTE: The DXS-31 & DXS-32 door/window sensors are pre-set at the factory for delayed burglary response. If the sensor is going to be used on a non-entry portal (window, sliding glass door, etc.) a jumper can be changed in the sensor to select instant response. The jumper should be changed before programming the sensor so the Control Panel will assign the sensor to the proper sensor function. See the "Basic Sensor Installation" section of this manual or the sensor's instructions for details on changing the jumper.**
- ◆ For DXS-81, DXS-91, DXS-54, DXS-73, & accessory sensors, simply send a test transmission (refer to the sensor's instructions for details on sending a test transmission).

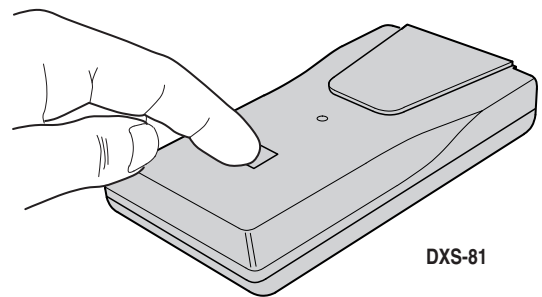
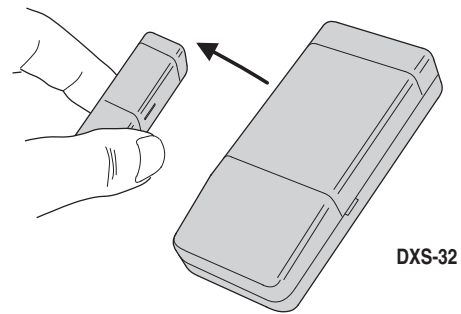

PROGRAMMING DIFFERENT SENSOR TYPES (CONT.)

- ◆ For DXT-61, DXT-21, DXS-21, DXT-41, & DXS-62A single-button remotes, simply press the unit's button.
- 📎 **NOTE:** After the Control Panel recognizes the transmitter, single-button remotes must be re-programmed as "panic buttons" or home automation controllers. Refer to Page 28 in the "Customizing the System" section of this manual.
- ◆ For DXT-23, DXS-23, & DXT-42 multi-button remotes: Learn the transmitter by pressing the **left** button. The remote will arm the Control Panel with the left button and disarm with the right button. Labels are provided with the DXT-42 for identifying the buttons.
- 📎 **NOTE:** After the Control Panel "learns" the transmitter, multi-button remotes can easily be re-programmed to have the left button arm/disarm the Control Panel and the right button activate/deactivate the Home Automation output. Refer to the "Advanced Programming" section of this manual.

For All Models:

- * A single "Bing" tone will sound and the sensor status indicator will stay lit when the sensor is programmed into the Control Panel.
- * A "Buzz" tone will sound if there is already another sensor programmed to that sensor number.
- ◆ Exit Setup Mode by pressing the **★** key then press **OFF** for three seconds. Reminder: The system will automatically exit the Setup Mode and return to Off Mode after three minutes of keypad inactivity.
- 📎 **NOTE:** To remove sensors from the Control Panel's memory, see Page 26 in the "Customizing the System" section of this manual.

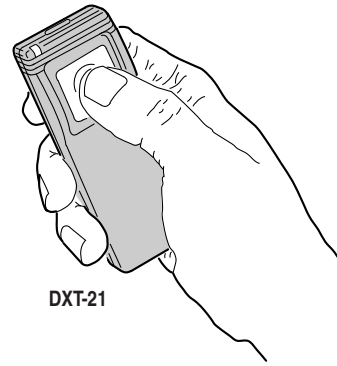

DXT-21

SEND SIGNAL WITH LEFT BUTTON

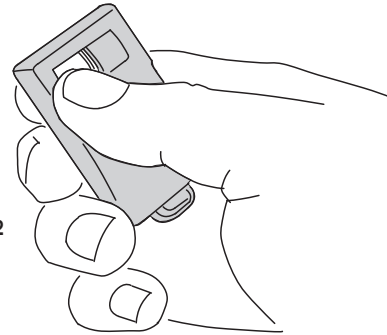

DXT-42

LEFT = ARM/DISARM
RIGHT = DISARM
BOTH = EMERGENCY

8. BASIC SENSOR INSTALLATION

- ◆ Each accessory sensor is packaged with its own set of installation instructions specific to the model of sensor.
- ◆ **Refer to the sensor's instructions for details on installing, operating, and testing of the sensor.**
- ◆ Following are basic instructions for installing two popular DUAL 824 accessories: The Model DXS-10 Wireless Remote Keypad and the Model DXS-31 & DXS-32 Door/Window Transmitters.

DXS-10 WIRELESS KEYPAD

- ◆ The DXS-10 is used to remotely operate the system.
- ◆ The keypad can be simply set on a table or mounted to a flat surface.

TABLE-TOP USE

- ◆ Four anti-mar pads are provided as a scratch deterrent for the keypad.
- 📎 **NOTE: Do not use the adhesive pads if the keypad is going to be wall mounted.**
- 1. Peel off the adhesive tape backing on the pads and stick them to the back of the keypad.
- ◆ The wireless keypad can be used as a portable keypad. Because of the hourly supervisory transmissions, if the unit is taken out of range from the Control Panel for more than eight hours, the hardwired keypad will indicate "radio trouble" for the wireless keypad. The keypad's sensor number can be programmed for "non-supervised" if required. See the "Advanced Programming" section of this manual.

WALL MOUNT USE

- ◆ The wireless keypad can be wall mounted.
- 1. Open the keypad by inserting a small screwdriver in one of the top slots in the keypad case. Gently twist the screwdriver until the case pops open.
- 2. Attach the rear case to the wall using the two screws provided.
- 📎 **NOTE: For best signal transmission, the keypad should be mounted at least three feet above ground level.**
- 3. Hook the top edge of the keypad case together and snap the keypad onto the rear case.
- 📎 **WARNING: The wireless keypad is designed for indoor use only.**

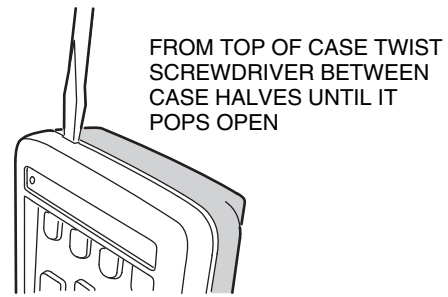

CONNECT BATTERY TO BATTERY CLIP

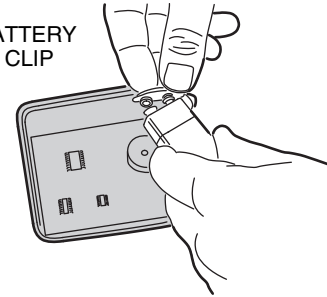

USE THE FOUR SCRATCH DETERRENT PADS PROVIDED FOR TABLE-TOP USE

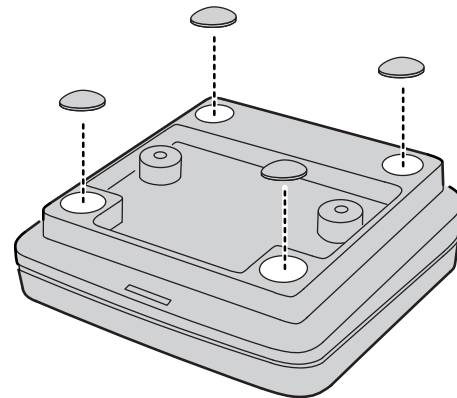

ATTACH REAR CASE TO WALL WITH THE TWO SCREWS PROVIDED

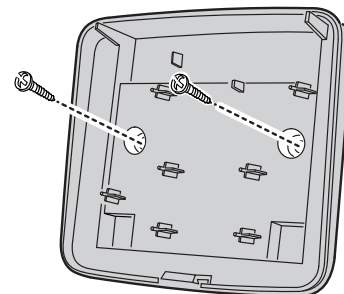

MOUNT AT A CONVENIENT LOCATION NEAR PRIMARY ENTRY/EXIT DOOR

DXS-31 & DXS-32 DOOR/WINDOW SENSORS

- ◆ The DXS-31 and DXS-32 sensors can be used to monitor doors, windows, cabinets, crawl space doors, gates, freezer doors, and many other moving objects that could be used for intrusion or need to be monitored.
- ◆ A built-in magnetic switch triggers the sensor when its magnet (mounted on the moving part or the door or window) moves away from the sensor.
- ◆ The DXS-31 sensor can be wired to external normally closed switches for remote triggering.
- ◆ The DXS-31 sensor can connect directly to a glass break detector.

SET SENSOR JUMPER

- ◆ A jumper inside the door/window sensor selects instant or delayed response.
- 1A. If the sensor is going to be used on the primary entry/exit door make sure that the jumper is in the DELAY position.
 - 1B. If the sensor is going to be used on a window or a door that is not going to be used to enter and exit the premises, set the jumper to the INSTANT position.

CHOOSE MOUNTING METHOD

- 2A. Apply double-stick tape (supplied) to back of sensors and magnets.
 - 2B. Screws are also provided to mount sensors and magnets. Screws are preferred over the double-stick tape in permanent installations.
- ✎ **UL NOTE: Double-stick tape is not allowed in UL installations.**

ATTACH SENSORS AND MAGNETS

- ◆ Allow a maximum of 1/2" between magnet and sensor when door/window is closed.
 - ◆ The magnet height is adjustable and an optional magnet spacer is provided for uneven surfaces.
- 3A. On doors, mount sensor to door frame and magnet to door.
 - 3B. On windows, mount sensor to window frame and magnet to window.
- ✎ **NOTE: Magnet must line up with mark on sensor case both horizontally & vertically.**
4. Snap sensor onto mounting plate.

TEST SENSORS

- * In Chime Mode, the hardwired keypad(s) should “ding-dong” when the sensor sends a signal.
5. Open door or window.
 - * Verify that light on the sensor (if there is one) glows momentarily when door/window is opened.
 - * Status indicator on the hardwired keypad(s) should remain lit for each door/window sensor that is left open.

EXAMPLE INSTALLATIONS (WITH DXS-31 SHOWN)

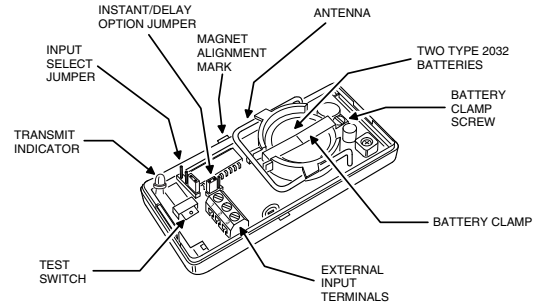
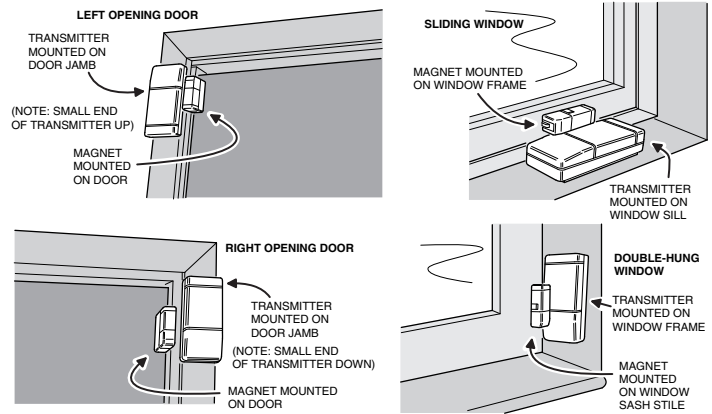

INSTANT/DELAY OPTION JUMPER

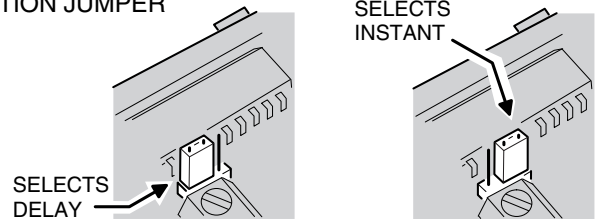

ATTACH MOUNTING PLATES USING THE SCREWS OR DOUBLE-STICK TAPE PROVIDED

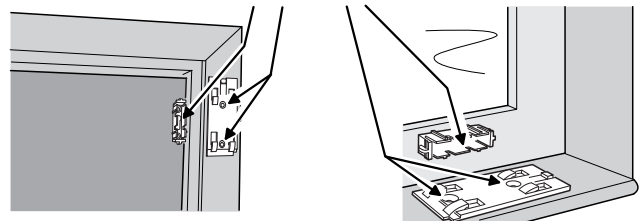

NOTE: ATTACHING THE TRANSMITTER WITH DOUBLE-STICK TAPE IS NOT ALLOWED IN UL INSTALLATIONS

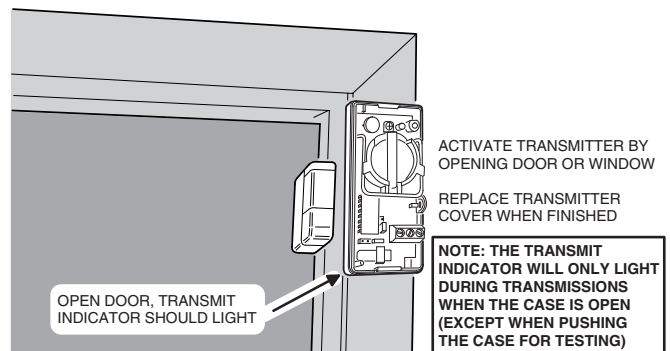

9. CUSTOMIZING THE KEYPAD

- ◆ The system can be customized for the specific installation.
- ◆ A label sheet with sensor location names is provided with DUAL 824KP keypads.
- ◆ Labeling the sensors allows quick and easy identification of where a door or window is open, where any alarms have occurred, where a sensor with a low battery is, or where a sensor with trouble is.

LABELING THE SENSOR LOCATIONS

1. Open the keypad's plastic beauty cover to reveal the sensor identification label area.
2. Open one protected door/window to light its sensor status light on the keypad(s).
3. Choose a label that describes the sensor location, or write the location on a blank label, and stick it in the area next to the sensor number.
4. Close the protected opening that you just labeled.
5. Repeat for each protected opening.
6. Stick the **WIRELESS KEYPAD** label in the sensor number location for the wireless keypad (if used).
7. Close the beauty cover when finished.

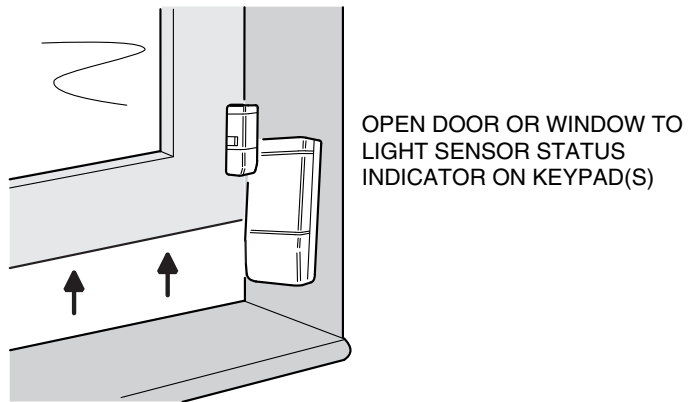
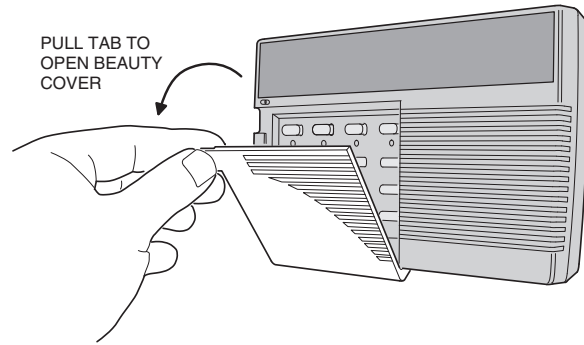

USE SENSOR LABELS SUPPLIED TO IDENTIFY EACH SENSOR LOCATION

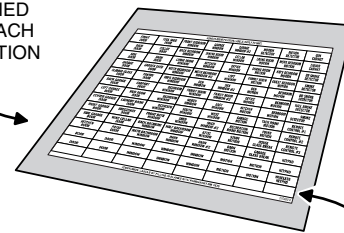

USE AN INK PEN TO CUSTOMIZE BLANK LABELS

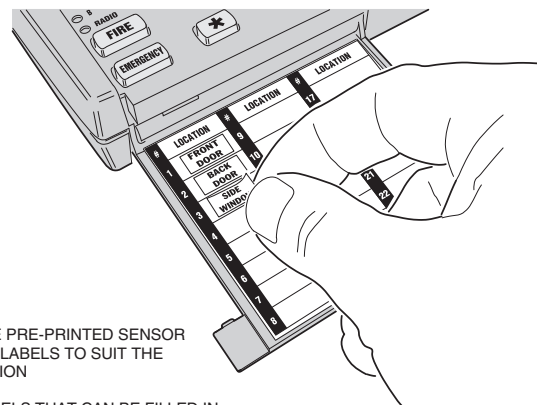

BLANK LABELS THAT CAN BE FILLED IN WITH AN INK PEN ARE ALSO PROVIDED FOR CUSTOM SENSOR IDENTIFICATION

10. SYSTEM OPERATING MODES

OFF MODE

- ◆ Use this mode to disarm the burglary portion of the system.
 - ◆ The 24-hour functions are still active in Off Mode and can be triggered with wireless or hardwired sensors, or by pressing the **FIRE** or **EMERGENCY** on the keypad(s).
 - 1. Switch to Off Mode by entering the user code, and pressing **OFF**.
- NOTE: The keypad's * key resets the keypad's keyboard and can be used before entering any code to assure that any digits recently pressed will not be added to the correct code. Pressing * first is optional because the keypad will reset itself after 10 seconds of keyboard inactivity.*
- * When the system is disarmed to Off Mode, the keypad(s) will sound one "Gong".
- ◆ **Switching to Off Mode stops any alarms in progress.**
 - * If an alarm has occurred, multiple Beeps will sound after disarming and the sensor indicator for the sensor(s) that caused the alarm will flash.
- NOTE: In Off Mode, protected doors and windows cannot trigger the burglary alarm.*

OFF MODE

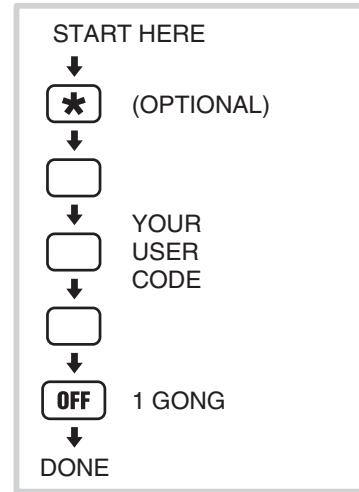

CHIME MODE

- ◆ Chime Mode is for monitoring entries and exits without causing alarms.
 - ◆ Use Chime Mode as an "automatic door chime" when at home.
 - * Opening any protected door or window causes the keypad(s) to sound a "ding-dong".
 - 1A. Select the Chime Mode by entering a user code, then press **CHIME**.
 - 1B. The user can enter Chime Mode from Off Mode by pressing **CHIME** for two seconds.
 - * When the system is switched to the Chime Mode, the keypad(s) will sound a "Gong" and one "Beep".
 - ◆ **Switching to Chime Mode disarms the system and stops any alarms in progress.**
 - * If an alarm has occurred, multiple Beeps will sound after disarming and the sensor indicator for the sensor(s) that caused the alarm will flash.
- NOTE: In Chime Mode, protected doors and windows cannot trigger the burglary alarm.*

CHIME MODE

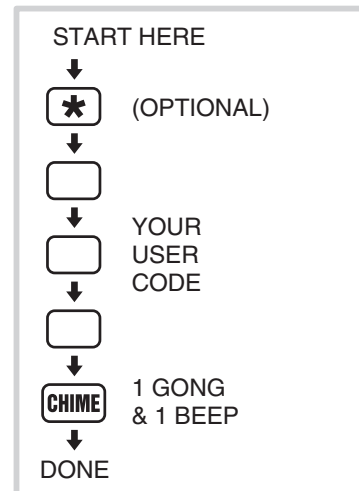

OR QUICK ARM TO CHIME MODE

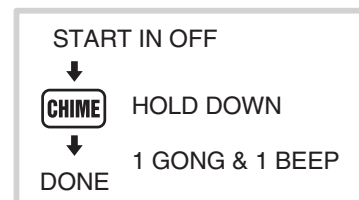

HOME MODE

- ◆ Use this mode when sleeping or when anyone is staying inside.
 - ◆ Home Mode causes an instant alarm when any perimeter sensor is triggered.
 - ◆ Home Mode causes a delayed alarm when any exit/entry sensor is triggered (except in Home Instant Mode when they are instant).
 - ◆ Each burglary sensor can trigger the siren once per arming period.
 - ◆ Alarm siren stops automatically after five minutes and the system will remain armed.
 - ◆ Home Mode ignores all interior sensors (motion detectors, etc.).
- 1A. Arm to Home Mode by entering a user code, and pressing **HOME**.
 - 1B. The user can “Quick Arm” to Home Mode from Off or Chime Mode by pressing **HOME** for two seconds. (Quick arming can be disabled; see the “Advanced Programming” section of this manual.)
 - * When the system is armed to the Home Mode, the keypad(s) will sound a “Gong” and two “Beeps”.
 2. Enter a user code and press **OFF** or **CHIME** to disarm from Home Mode and/or stop the alarm siren.
 - * If an alarm has occurred, multiple Beeps will sound after disarming and the sensor indicator for the sensor(s) that caused the alarm will flash (switch to Off Mode again or re-arm the system to stop the flashing alarm memory).

SECURE EXIT

1. If the system is already in the Home Mode and the user wants to exit the premises while leaving someone inside *with the system still in Home Mode*, enter a user code and press the **HOME** key.
 - * The **HOME** light will blink for 60 seconds. No exit delay Beeps will sound during the Exit Delay.
- 2A. The user can leave through a door with a delayed perimeter sensor during the 60 second Exit Delay without causing the Control Panel to begin an Entry Delay.
- 2B. Re-entering during the silent Exit Delay will extend the Exit Delay another 60 seconds (one time only).
 - * **NOTE: The Exit Delay time can be changed; see the “Advanced Programming” section of this manual.**

HOME INSTANT MODE

1. If the system is already in the Home Mode and the user wants to make all exit/entry sensors instant, press **HOME** for two seconds.
 - * Two “Gongs” and two “Beeps” will sound and the **HOME** light and **ARMED** indicator will blink continuously.
2. Because all exit/entry sensors will now cause an instant alarm when in Home Mode, the system must be disarmed before opening any exit/entry delay door.
 - * **NOTE: If quick arming is disabled the Home Instant Mode is unavailable.**

MANUAL BYPASSING OF SENSORS

- ◆ Manual bypassing of sensors in the Home Mode allows arming of the system at night with open windows, while still having perimeter protection with other closed doors and windows.
 - ◆ If the **READY** indicator is lit, all sensors are closed.
1. If the **READY** indicator is not lit, the system will resist arming because of open door or window sensors.
 - * Four high-low Beeps to warn the user that something is open and the system will remain in the previous mode.
 - * Lit sensor status indicators show which sensors are open.
 2. To manually bypass the open sensors, arm the system again within five seconds.
 - * A “Gong” and two “Beeps” will sound, the **HOME** indicator will light, and the open sensors will be bypassed.
- 🔔 **WARNING: Bypassed sensors cannot cause an alarm. Closing the sensor removes the bypass.**

HOME MODE

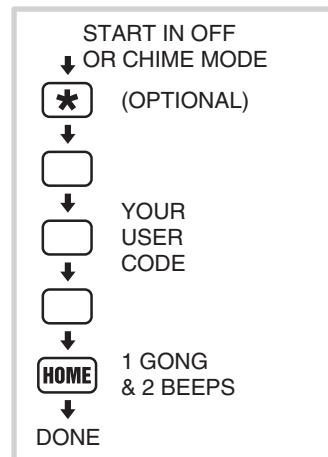

SECURE EXIT

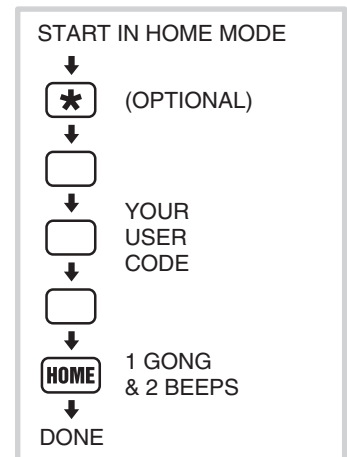

OR QUICK ARM TO HOME MODE

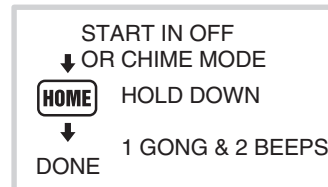

HOME INSTANT MODE

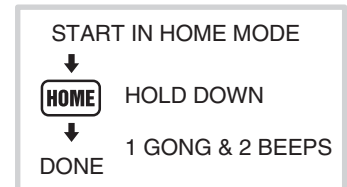

AWAY MODE

- ◆ Use this mode when no one will be staying home.
 - ◆ Away Mode causes an **instant** alarm when any perimeter sensor is triggered.
 - ◆ Away Mode causes a **delayed** alarm when any exit/entry sensor is triggered.
 - ◆ Away Mode causes an **instant** alarm when any interior sensors (motion detectors, etc.) are triggered. The interior sensors will be **delayed** if a perimeter delayed sensor is triggered first.
 - ◆ Each burglary sensor can trigger the siren once per arming period.
 - ◆ Alarm siren stops automatically after five minutes and the system will remain armed.
- 1A. Arm to Away Mode by entering a user code, and pressing **AWAY**.
 - 1B. The user can “Quick Arm” to Away Mode from Home, Chime or Off Mode by pressing **AWAY** for two seconds. (Quick arming can be disabled; see the “Advanced Programming” section of this manual.)

EXIT DELAY (For Leaving the Premises)

- * When the system is armed to the Away Mode, the keypad(s) will sound a “Gong” and three “Beeps”.
 - * During the 60 second Exit Delay, the keypad(s) will sound “Beeps” (double Beeps last 10 seconds) and the **AWAY** and **ARMED** indicators will blink.
- 2A. The Exit Delay gives the user 60 seconds to leave the premises through an exit/entry door without triggering an alarm.
 - 2B. Re-entering during the Exit Delay will extend the Exit Delay another 60 seconds (one time only).
 - * When the Exit Delay is over, the keypad(s) will sound one “Gong” to warn the user that the system is fully armed and the **ARMED** indicator will light steady.
-  **NOTE: The Exit Delay time can be changed; see the “Advanced Programming” section of this manual.**

ENTRY DELAY (For Entering the Premises)

- 3A. The Entry Delay gives the user 30 seconds to enter the premises through an exit/entry door without triggering an alarm.
 - 3B. If a exit/entry sensor is triggered, starting the Entry Delay, the interior sensors will also become delayed (this allows motion in the premises during the Entry Delay).
 - * During the 30 second Entry Delay, the keypad(s) will sound “Beeps”.
 4. When the Entry Delay is over, the system will go into full alarm and sound the siren if it is not disarmed to the Off or Chime Mode.
 - * If an alarm has occurred while the user was gone, multiple Beeps will sound after disarming and the sensor light for the sensor(s) that caused the alarm will flash (switch to Off Mode again or re-arm the Control Panel to stop the flashing alarm memory).
-  **NOTE: The Entry Delay time can be changed; see the “Advanced Programming” section of this manual.**

MANUAL BYPASSING OF SENSORS

- ◆ Manual bypassing of sensors in the Away Mode allows arming of the system with open doors and windows, while still having perimeter protection with other closed doors and windows.
 - ◆ If the **READY** indicator is lit, all sensors are closed.
1. If the **READY** indicator is not lit, the system will resist arming because of open door or window sensors.
 - * Four high-low Beeps to warn the user that something is open and the system will remain in the previous mode.
 - * Lit sensor status indicators show which sensors are open.
 2. To manually bypass the open sensors, arm the system again *within five seconds*.
 - * A “Gong” and three “Beeps” will sound, the **AWAY** indicator will light, and the open sensors will be bypassed.
-  **WARNING: Bypassed sensors cannot cause an alarm. Closing the sensor removes the bypass.**

AWAY MODE

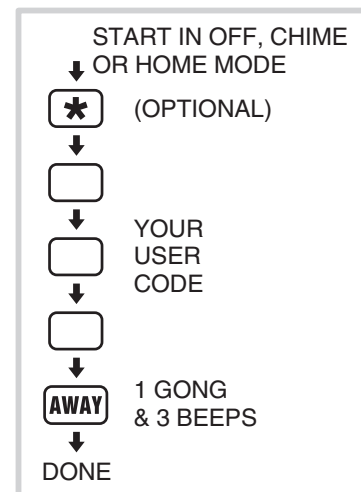

OR QUICK ARM TO AWAY MODE

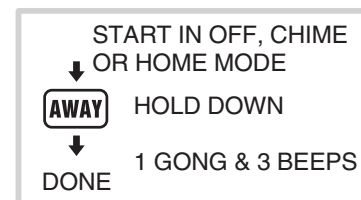

TEST MODE

- ◆ Even though this is a self-monitoring supervised system, the National Burglar and Fire Alarm Association recommends that all security systems be tested manually on a regular basis.
 1. The system must be in Off Mode before switching to Test Mode.
 2. Switch the system into Test Mode by entering a user code and pressing **TEST**.
 - * When the system is switched to the Test Mode, the keypad(s) will sound a "Gong" and four "Beeps".
 3. Holding down the **TEST** button in Test Mode will light all of the keypad's indicators.
 - * The sensor status indicators will flash for each sensor programmed into the Control Panel.
 4. Go to each sensor and press its test button or open and close the protected opening.
 5. To test the wireless keypad, press the wireless keypad's **A** key.
 - * The keypad(s) will make a "Bing" sound as each sensor is tested, followed by 1-3 beeps indicating signal strength with 3 beeps being the strongest signal.
 - * As each sensor is tested, the sensor status indicator for the sensor will stop flashing and return to showing the current status of the sensor.
 6. Continue testing until there are no flashing sensor status indicators.

📌 **NOTE:** If the system is left unattended in Test Mode, it will automatically switch back to Off Mode after three minutes.

- ◆ When directly connecting (without a telephone line) to the DUAL 824 with the RA-2400 remote access software (Version 1.3 or later), press the **EMERGENCY** key while in Test Mode to cause the control panel to connect to the modem.

TEST MODE

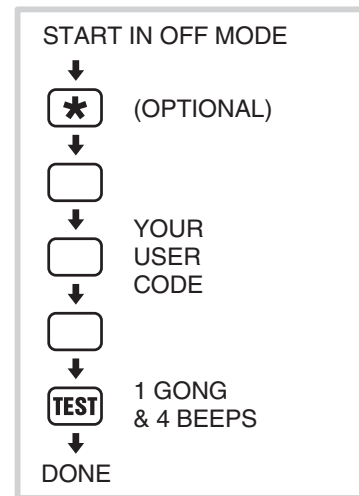

SENSOR OPERATION IN EACH SYSTEM MODE

SENSOR FUNCTION	OFF MODE	CHIME MODE	HOME MODE	AWAY MODE
AUTOMATION	ACTIVATES AND DEACTIVATES THE AUTOMATION OUTPUT			
EMERGENCY	ARMED 24-HOURS - TRIGGERS EMERGENCY ALARM			
PANIC	ARMED 24-HOURS - TRIGGERS SILENT PANIC ALARM			
FIRE	ARMED 24-HOURS - TRIGGERS FIRE ALARM			
PERIMETER	DEACTIVATED	CHIME	INSTANT BURGLARY ALARM	
EXIT/ENTRY	DEACTIVATED	CHIME	DELAYED BURGLARY ALARM	
INTERIOR	DEACTIVATED	DEACTIVATED	DEACTIVATED	INSTANT BURGLARY ALARM UNLESS ACTIVATED DURING AN ENTRY DELAY, THEN IT IS DELAYED
CHIME	CHIME			
2-BUTTON ARM/DISARM (LEFT) 2-BUTTON AUTOMATION (RIGHT) EMERGENCY (BOTH BUTTONS)	LEFT BUTTON SWITCHES SYSTEM TO AWAY MODE † IF ALARM MEMORY IS ACTIVE, SWITCHES SYSTEM TO OFF MODE ‡		LEFT BUTTON SWITCHES SYSTEM TO OFF MODE ‡	
2-BUTTON ARM (LEFT) 2-BUTTON DISARM (RIGHT) EMERGENCY (BOTH BUTTONS)	LEFT BUTTON SWITCHES SYSTEM TO AWAY MODE † IF ALARM MEMORY IS ACTIVE, SWITCHES SYSTEM TO OFF MODE ‡		RIGHT BUTTON SWITCHES SYSTEM TO OFF MODE ‡	
ENVIRONMENTAL	ARMED 24-HOURS - TRIGGERS ANNUNCIATION ONLY			
INTERIOR HOME	DEACTIVATED	DEACTIVATED	INSTANT BURGLARY ALARM	

† CAN BE HOME MODE USING PROGRAMMING STEP 50

‡ CAN BE CHIME MODE USING PROGRAMMING STEP 51

SENSOR FUNCTION TABLE

11. SYSTEM TROUBLE INDICATIONS

- ◆ The DUAL 824P Control Panel is a self-monitoring supervised wireless system. If the Control Panel detects a problem with any of the supervised system sensors or with its power, it will display the appropriate trouble indication and, if monitored, report the trouble to the Central Station through the communicator (depending on communicator programming).

CONTROL PANEL POWER

- ◆ The Control Panel constantly charges and monitors the optional backup battery (if installed).
 - * The **POWER** indicator normally glows when AC power is on.
- ◆ If the Control Panel's power condition is abnormal, the keypad's **TROUBLE** indicator will light. The **POWER** light will indicate the type of trouble.
 - * With a charged backup battery installed, if the Control Panel loses AC power, the **POWER** indicator will blink as the Control Panel runs on the backup battery.
 - * If the backup battery is low, recharging, or not installed, the **POWER** indicator blinks when AC power is present.
 - * If the AC power is off and no backup battery is installed, or the battery fuse is blown, the **POWER** indicator will be off (in this case, the system has no power, all indicators are dark, and the system is disabled).
- ◆ Normal battery life for the type of backup battery used in the Control Panel is 3-4 years. If the battery does not take a charge in 72 hours, it should be replaced.

WIRELESS SENSOR LOW BATTERIES

- * If the **TROUBLE** indicator lights, and the **BATTERIES** indicator is blinking, one or more wireless sensors have a low battery.
1. Press ***** for one second to view sensor status. The sensor status indicator for any sensor with a low battery will light along with the **BATTERIES** indicator.
 2. Replace the wireless sensor's battery as described in its instructions.
 3. Switch to Test Mode after replacing the wireless sensor battery and completely test the system (see Test Mode). Switching to Test Mode clears the trouble indication.

SENSOR RADIO TROUBLE

- * If the **TROUBLE** indicator lights, and the **RADIO** indicator is blinking, status reports from one or more wireless sensors have not received in eight hours.
1. Press ***** for one second to view sensor status. The sensor status indicator for any sensor with trouble will light along with the **RADIO** indicator.
 2. Switch to Test Mode after servicing the sensor and completely test the system (see Test Mode). Switching to Test Mode clears the trouble indication.

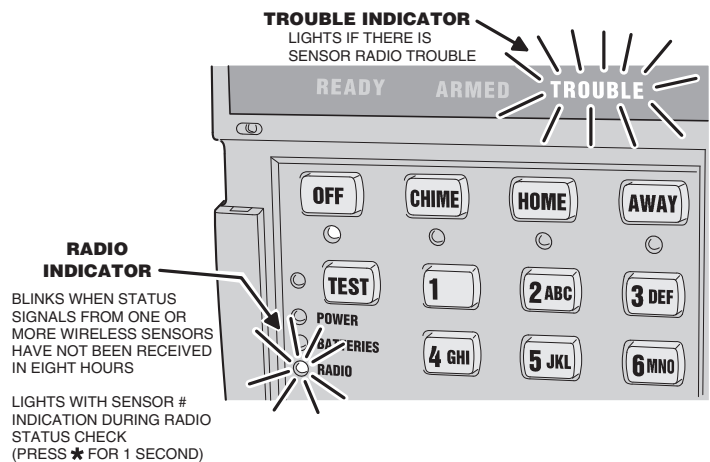
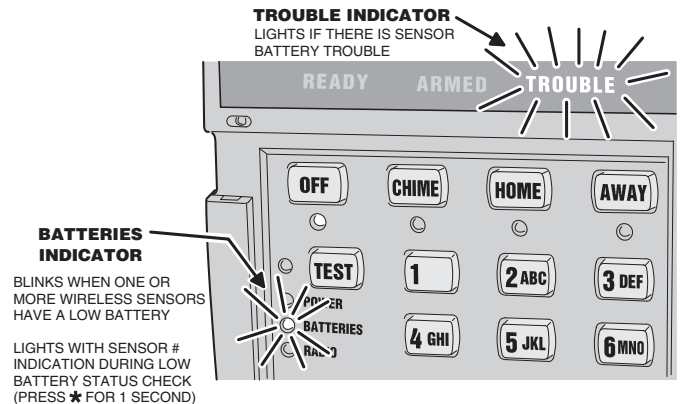
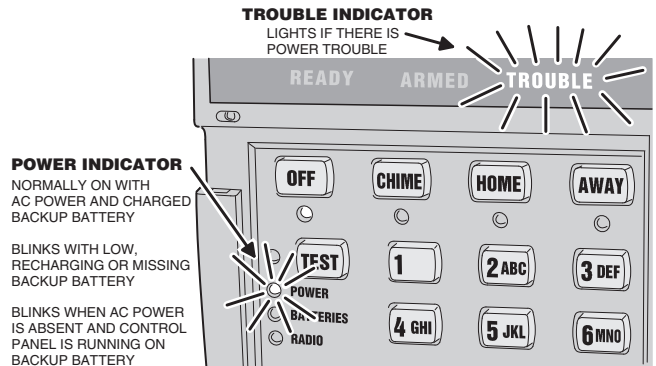

12. CUSTOMIZING THE SYSTEM

- ◆ Adding additional sensors will increase the protection provided by the system.
- ◆ All ground-level perimeter openings and accessible upper-story openings need protection.
- ◆ Motion detectors can protect interior areas and areas where valuables are kept.

ADDING SENSORS TO THE SYSTEM

1. Always start with the system in Test Mode (enter a user code and press **TEST**).
2. Enter the master user code then press **TEST**.
 - * A "Gong" and five "Beeps" will sound.
 - * The sensor status indicators will light for each sensor programmed into the Control Panel.
3. Enter an unused sensor number from 01-24 (you must enter two digits, example: 5 = 05).
 - 📎 **NOTE: A sensor can be programmed into more than one location. Be sure to choose an UNUSED sensor number. If a sensor gets entered into more than one location, delete the duplicates using the remove sensor function.**
 - * The sensor status indicator light will flash for the sensor number selected.
4. Activate the sensor. (To add a wireless keypad, press the keypad's * key.)
 - * A "Bing" tone will sound when the sensor is programmed into the Control Panel and the sensor status indicator will stay lit.
 - * A "Buzz" tone will sound if there is already another sensor programmed to that sensor number.
5. Enter another sensor number, or exit Setup Mode by pressing the * key then press **OFF** for three seconds.

REMOVING SENSORS FROM THE SYSTEM

- ◆ If a previously programmed sensor isn't going to be used with the system anymore, or it's a duplicate that has been entered into more than one sensor location, it should be removed from the Control Panel's memory.
1. Start with the system in Test Mode.
 2. Enter the **master** user code then press **TEST**.
 - * A "Gong" and five "Beeps" will sound.
 - * The sensor status indicators will light for each sensor programmed into the Control Panel.
 3. Enter the sensor number (from 01-24) that you want to remove (you must enter two digits, example: 5 = 05).
 - * The sensor status indicator light will flash for the sensor number selected.
 4. Press **TEST**.
 - * A "Bing" tone will sound when the sensor has been removed and the sensor status indicator will turn off.
 5. Enter another sensor number, or exit Setup Mode by pressing the * key then press **OFF** for three seconds.

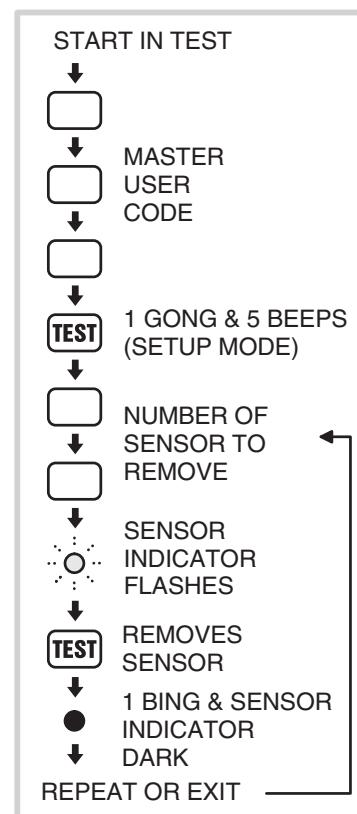
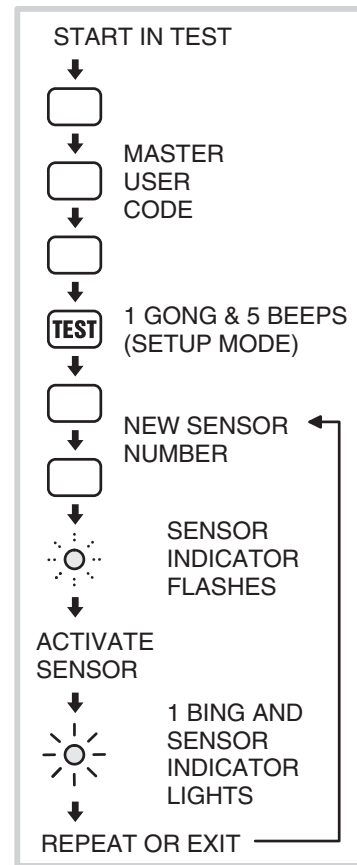

MAKING A SENSOR A 24-HOUR DOOR CHIME

- ◆ Sensors can be programmed to cause the keypad(s) to chime any time they're activated.
 - ◆ Chime-only sensors will not be able to trigger the alarm in any system mode.
 - ◆ The sensor must have already been programmed into the Control Panel (see “Adding Sensors to the System” for details).
1. Start with the system in Test Mode.
 2. Enter the master user code then press **TEST**.
 - * A “Gong” and five “Beeps” will sound.
 - * The sensor status indicators will light for each sensor programmed into the Control Panel.
 3. Enter the sensor number from 01-24 (you must enter two digits, example: 5 = 05).
 - * The sensor status indicator light will flash for the sensor number selected.
 4. Press **HOME**, **8**, then **AWAY**.
 - * A “Bing” tone will sound and the sensor status indicator will light steady.
 5. Enter another sensor number, or exit Setup Mode by pressing the ***** key then press **OFF** for three seconds.

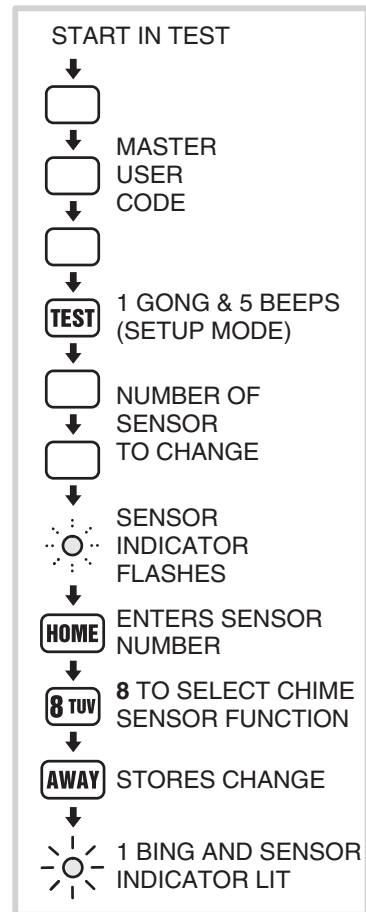

MAKING A SENSOR INTERIOR

- ◆ Wireless motion detectors are automatically programmed as interior sensors. Any other sensor can also be programmed as an interior sensor.
 - ◆ Interior sensors can only trigger an alarm when the system is in the Away Mode.
 - ◆ “Home Interior” sensors can trigger an alarm when the Control Panel is in the Home or Away mode.
 - ◆ The sensor must have already been programmed into the Control Panel (see “Adding Sensors to the System” for details).
1. Start with the system in Test Mode.
 2. Enter the master user code then press **TEST**.
 - * A “Gong” and five “Beeps” will sound.
 - * The sensor status indicators will light for each sensor programmed into the Control Panel.
 3. Enter the sensor number from 01-24 (you must enter two digits, example: 5 = 05).
 - * The sensor status indicator light will flash for the sensor number selected.
 4. Press **HOME**, **7**, then **AWAY**.
 - * A “Bing” tone will sound and the sensor status indicator will light steady.
 5. Enter another sensor number, or exit Setup Mode by pressing the ***** key then press **OFF** for three seconds.

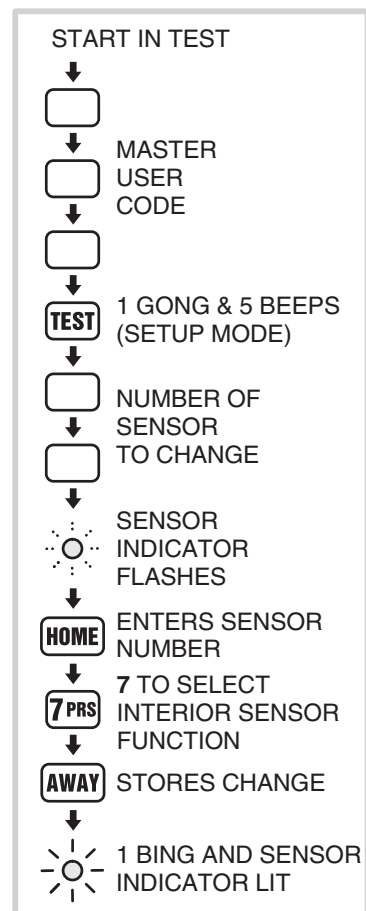

MAKING A SENSOR PERFORM A DIFFERENT FUNCTION

- ◆ Sensors can be reprogrammed to perform different sensor functions.
 - ◆ The sensor must have already been programmed into the Control Panel (see “Adding sensors to the System” for details).
1. Start with the system in Test Mode.
 - * A “Gong” and five “Beeps” will sound.
 - * The sensor status indicators will light for each sensor programmed into the Control Panel.
 2. Enter the master user code then press **TEST**.
 - * A “Gong” and five “Beeps” will sound.
 - * The sensor status indicators will light for each sensor programmed into the Control Panel.
 3. Enter the sensor number from 01-24 (you must enter two digits, example: 5 = 05).
 - * The sensor status indicator light will flash for the sensor number selected.
 4. Choose a sensor function number from the Sensor Function Table.
 5. Press **HOME**, the new sensor function number, then **AWAY**.
 - * A “Bing” tone will sound and the sensor status indicator will light steady.
 6. Enter another sensor number or exit Setup Mode by pressing the ***** key then press **OFF** for three seconds.

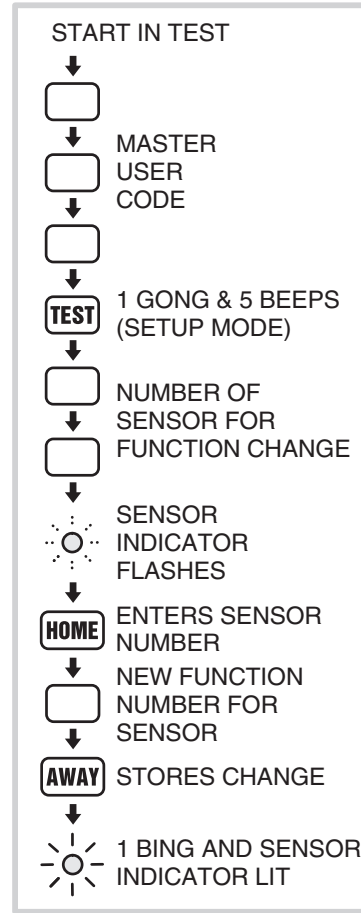

PROGRAMMING INFORMATION		SENSOR OPERATION IN EACH SYSTEM MODE			
FUNCTION #	SENSOR FUNCTION	OFF MODE	CHIME MODE	HOME MODE	AWAY MODE
1	AUTOMATION	ACTIVATES AND DEACTIVATES THE AUTOMATION OUTPUT			
2	EMERGENCY	ARMED 24-HOURS - TRIGGERS EMERGENCY ALARM			
3	PANIC	ARMED 24-HOURS - TRIGGERS SILENT PANIC ALARM			
4	FIRE	ARMED 24-HOURS - TRIGGERS FIRE ALARM			
5	PERIMETER	DEACTIVATED	CHIME	INSTANT BURGLARY ALARM	
6	EXIT/ENTRY	DEACTIVATED	CHIME	DELAYED BURGLARY ALARM	
7	INTERIOR	DEACTIVATED	DEACTIVATED	DEACTIVATED	INSTANT BURGLARY ALARM UNLESS ACTIVATED DURING AN ENTRY DELAY, THEN IT IS DELAYED
8	CHIME	CHIME			
9	2-BUTTON ARM/DISARM (LEFT) 2-BUTTON AUTOMATION (RIGHT) EMERGENCY (BOTH BUTTONS)	LEFT BUTTON SWITCHES SYSTEM TO AWAY MODE † IF ALARM MEMORY IS ACTIVE, SWITCHES SYSTEM TO OFF MODE ‡		LEFT BUTTON SWITCHES SYSTEM TO OFF MODE ‡	
10	2-BUTTON ARM (LEFT) 2-BUTTON DISARM (RIGHT) EMERGENCY (BOTH BUTTONS)	LEFT BUTTON SWITCHES SYSTEM TO AWAY MODE † IF ALARM MEMORY IS ACTIVE, SWITCHES SYSTEM TO OFF MODE ‡		RIGHT BUTTON SWITCHES SYSTEM TO OFF MODE ‡	
11	ENVIRONMENTAL	ARMED 24-HOURS - TRIGGERS ANNUNCIATION ONLY			
12	INTERIOR HOME	DEACTIVATED	DEACTIVATED	INSTANT BURGLARY ALARM	

† CAN BE HOME MODE USING PROGRAMMING STEP 50

‡ CAN BE CHIME MODE USING PROGRAMMING STEP 51

SENSOR FUNCTION TABLE

13. ADVANCED PROGRAMMING

- ◆ To perform any of the advanced programming steps, the system must be in the Setup Mode.
- ◆ Each programming function is performed with similar keystrokes. After the system is in Setup Mode, enter the programming step or sensor number and press **HOME**, then enter the new value and press **AWAY**. For reference, follow the figures next to the programming steps.
 - * If the new value is accepted, a “bing” will sound. If the new value is not accepted, a “double buzz” will sound.

HOME ENTERS PROGRAM STEP OR SENSOR NUMBER TO MODIFY

AWAY STORES NEW VALUE

SETUP MODE

1. Start with the system in Test Mode (Setup Mode cannot be reached from any other mode).
2. From Test Mode, enter the master user code then press **TEST**.
 - ✎ **NOTE: Only the master user code can be used to put the system into the Setup Mode. The restricted user codes cannot access Setup Mode, only Code Mode.**
 - * A “Gong” and five “Beeps” will sound, signaling that the system is in Setup Mode.
3. After programming changes are complete, press the **OFF** key for three seconds to exit Setup Mode.
 - ✎ **NOTE: If the system is left unattended in Setup Mode, it will automatically switch back to Off Mode after three minutes.**

CONTROL PANEL PROGRAMMING OPTIONS				
STEP #	PROGRAMMING FUNCTIONS	POSSIBLE VALUES	FACTORY VALUE	INSTALLATION VALUE
25	ENTRY DELAY	20-255 SECONDS	30	
26	EXIT DELAY	20-255 SECONDS	60	
30	BURGLARY SIREN TIME	1-30 MINUTES	5	
31	EMERGENCY SIREN TIME	1-30 MINUTES	5	
32	FIRE SIREN TIME	1-30 MINUTES	5	
40	AUTOMATION OUTPUT TIME	0-2500 SECONDS (0 = TOGGLE ON/OFF)	0	
50	REMOTE ARMING MODE	2 = HOME MODE; 3 = AWAY MODE	3	
51	REMOTE DISARMING MODE	0 = OFF MODE; 1 = CHIME MODE	0	
61	ENTRY DELAY BEEPS	0 = OFF; 1 = ON	1	
62	EXIT DELAY BEEPS	0 = OFF; 1 = ON	1	
63	SILENT BURGLARY ALARM	0 = AUDIBLE; 1 = SILENT	0	
64	SILENT EMERGENCY ALARM	0 = AUDIBLE; 1 = SILENT	0	
65	QUICK ARMING	0 = OFF; 1 = ON	1	
66	AUTO RESTORE	0 = OFF; 1 = ON	1	
67	AUTO BYPASS	0 = OFF; 1 = ON	0	
68	AUTOMATION MODE DURING ALARM	0 = FLASH (ENABLED BY FUNCTION 72) 1 = STEADY (ENABLED BY FUNCTION 72)	0	
69	AUTOMATION BING TOME	0 = NO BINGS 1 = BINGS	1	
70	REMOTE ARM/DISARM CHIRP	0 = NO CHIRPS 1 = CHIRPS (1 CHIRP = ARMED, 2 CHIRPS = DISARMED)	1	
71	AUTOMATION FLASHES AFTER ALARM	0 = STANDARD 1 = FLASHING AFTER ALARM	0	
72	AUTOMATION ACTIVE DURING ALARM	0 = STANDARD 1 = AUTOMATION ACTIVE DURING ALARM (FLASH OR STEADY PROGRAMMED BY FUNCTION 68)	0	
73	AUTOMATION ON WHILE ARMED	0 = STANDARD 1 = ON WHILE ARMED	0	
74	AUTOMATION ON DURING EXIT/ENTRY	0 = STANDARD 1 = ON DURING EXIT/ENTRY DELAY	0	
75	AUTOMATION POLARITY	0 = + WHEN OFF; 1 = + WHEN ON	1	
87	REMOTE ACCESS PASSWORD	6 DIGITS	987654	
92	DURESS CODE	1-5 DIGITS	REMOVED	
93	RESTRICTED USER CODE #1	1-5 DIGITS	REMOVED	
94	RESTRICTED USER CODE #2	1-5 DIGITS	REMOVED	
95	RESTRICTED USER CODE #3	1-5 DIGITS	REMOVED	
96	RESTRICTED USER CODE #4	1-5 DIGITS	REMOVED	
97	RESTRICTED USER CODE #5	1-5 DIGITS	REMOVED	
98	PAGE ALERT USER CODE	1-5 DIGITS	REMOVED	
99	MASTER USER CODE	1-5 DIGITS	1234	

Control Panel Programming Table

CHANGING A SENSORS SUPERVISION

- ◆ When a wireless sensor is programmed, the Control Panel automatically sets it to supervised or non-supervised. The hardwire loops are always supervised for end-of-line resistor termination.
- ◆ The Control Panel expects hourly status transmissions from any wireless sensor programmed as supervised.
- ◆ Any wireless sensor can be programmed as supervised or non-supervised using this process.
- 📎 **NOTE: Don't program a wireless sensor that doesn't send status transmissions as supervised.**

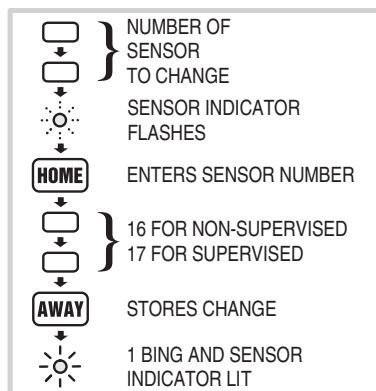

CHANGING A SENSORS RESTORE REQUIREMENTS

- ◆ When a wireless sensor is programmed, the Control Panel automatically recognizes it as manual or automatic restoring. The hardwired loops are always manual restoring.
- ◆ The Control Panel expects restoral signals from any wireless sensor programmed as manual restore.
- ◆ Any wireless sensor can be programmed as manual or automatic restore using this process.
- 📎 **NOTE: Don't program a wireless sensor that doesn't send restoral transmissions as manual restore.**

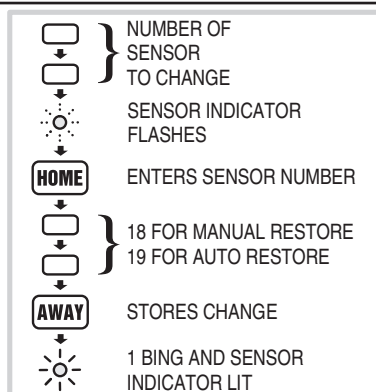

ENTRY DELAY TIME

- ◆ The factory-set Entry Delay time is 30 seconds.
- STEP #25** The Entry Delay time can be adjusted from 20 to 255 seconds using this step. Write the new Entry Delay time in the User's Guide.
- 📎 **NOTE: Don't make the Entry Delay too short. The user may not have enough time to disarm the system before an alarm.**

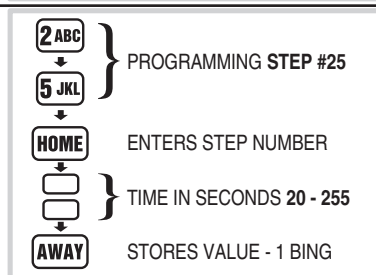

EXIT DELAY TIME

- ◆ The factory-set Exit Delay time is 60 seconds.
- STEP #26** The Exit Delay time can be adjusted from 20 to 255 seconds using this step. Write the new Exit Delay time in the User's Guide.

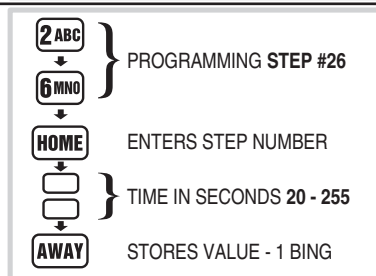

BURGLARY SIREN TIME

- ◆ The factory-set burglary siren time is five minutes (UL installation maximum).
- STEP #30** The burglary siren time can be adjusted from one to 30 minutes using this step.

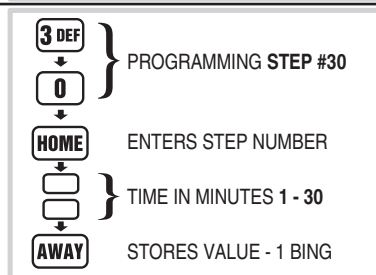

EMERGENCY SIREN TIME

- ◆ The factory-set emergency siren time is five minutes (UL installation maximum).
- STEP #31** The emergency siren time can be adjusted from one to 30 minutes using this step.

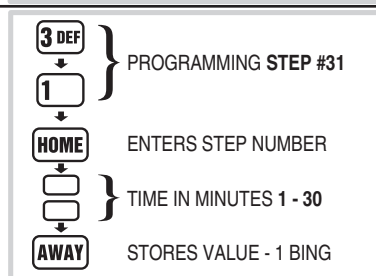

FIRE SIREN TIME

- ◆ The factory-set fire siren time is five minutes (UL installation maximum).

STEP #32 The fire siren time can be adjusted from one to 30 minutes using this step.

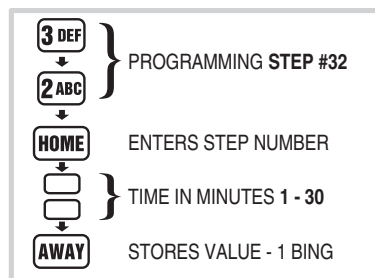

AUTOMATION OUTPUT TIME

- ◆ The factory setting causes the Automation Output to toggle between on and off with each activation.

STEP #40 The Automation Output can be programmed to turn on, then automatically turn off after one to 2500 seconds (42 minutes), or toggle on & off, using this step.

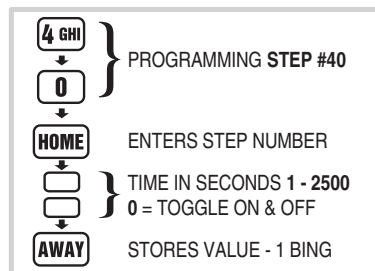

REMOTE CONTROL & HARDWIRE ARMING LEVEL

- ◆ The factory setting causes the portable remote controls to arm to the Away Mode.

STEP #50 The portable remote controls can be changed to arm to the Home Mode using this step.

NOTE: Changing this setting will affect all the portable remote controls used with the system and all hardwired loops programmed as arm/disarm (sensor Function #9) key stations.

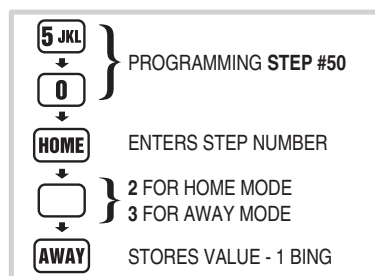

REMOTE CONTROL & HARDWIRE DISARMING LEVEL

- ◆ The factory setting causes the portable remote controls to disarm to the Off Mode.

STEP #51 The remote controls can be changed to disarm to the Chime Mode using this step.

NOTE: Changing this setting will affect all the portable remote controls used with the system and all hardwired loops programmed as arm/disarm (sensor Function #9) key stations.

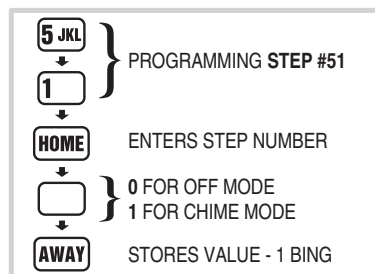

ENTRY DELAY BEEPS

- ◆ The factory setting causes the keypad(s) to beep during Entry Delays.

STEP #61 The Entry Delay beeps can be silenced using this step.

- ◆ With the Entry Delay beeps off, the keypad(s) will be silent after a delayed sensor is triggered until the Entry Delay expires, then the alarm siren will sound.

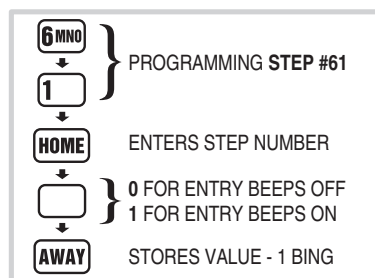

EXIT DELAY BEEPS

- ◆ The factory setting causes the keypad(s) to beep during Exit Delays.

STEP #62 The Exit Delay beeps can be silenced using this step.

- ◆ With the Exit Delay beeps off, the keypad(s) will be silent after arming to the Away Mode until the Exit Delay expires, then a single "Gong" tone will sound.

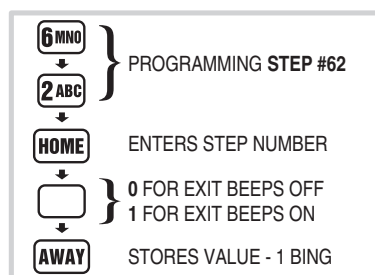

SILENT BURGLARY ALARMS

- ◆ The factory setting causes audible burglary alarms.

STEP #63 The Control Panel can be programmed for silent burglary alarms using this step.

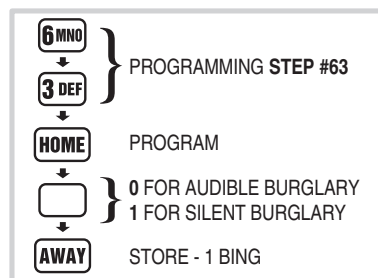

SILENT EMERGENCY ALARMS

- ◆ The factory setting causes audible emergency alarms.

STEP #64 The Control Panel can be programmed for silent emergency alarms using this step.

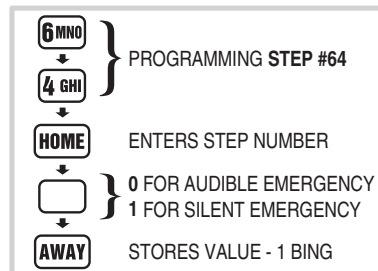

DISABLING QUICK ARMING

- ◆ The factory setting allows quick arming of the Control Panel by pressing down the mode keys for two seconds.

STEP #65 The Control Panel can be programmed to not allow quick arming using this step. If quick arming is disabled, a user code *must* be entered before pressing the mode buttons.

- 📎 **NOTE: For commercial installations with retail traffic, it is recommended to disable quick arming to prevent customers from arming the system.**
- 📎 **NOTE: If quick arming is disabled the Home Instant Mode is unavailable.**

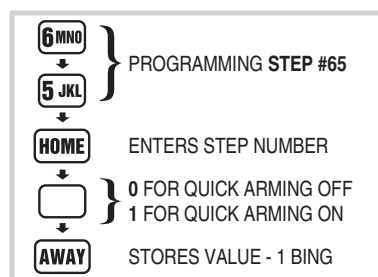

AUTOMATIC RESTORAL OF BYPASSED SENSORS

- ◆ Bypassed sensors are ignored by the Control Panel and cannot cause an alarm.
- ◆ The factory setting causes the Control Panel to automatically restore (remove the bypass from) sensors that close. After it's restored, the sensor is ready to cause an alarm the next time it is opened.

STEP #66 The Control Panel can be programmed to not automatically restore any bypassed sensor when the sensor closes using this step. Bypassed sensors will then remain bypassed until the system is disarmed.

- 📎 **NOTE: This setting affects all sensors.**

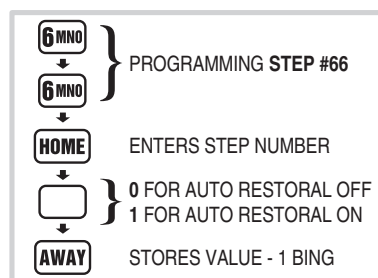

AUTOMATIC BYPASSING OF OPEN SENSORS

- ◆ The factory setting requires the user to manually bypass any open sensors when the system is armed.

* If arming is attempted with open sensors, the keypad(s) will sound five two-tone Beeps and will not arm.

- ◆ Arming to the same mode again within five seconds will bypass any open sensors and arm the Control Panel.

STEP #67 The Control Panel can be programmed to automatically bypass any open sensors when the system is armed using this step.

- 📎 **NOTE: This setting affects all sensors.**

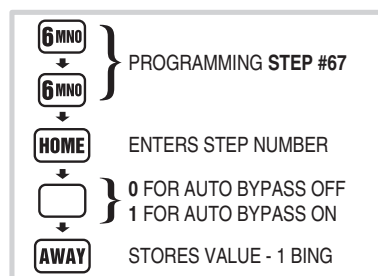

AUTOMATION OUTPUT MODE DURING ALARM

- ◆ The factory setting causes the Automation Output to flash if it is programmed to activate during or after an alarm.

 **NOTE: For the Automation Output to activate during or after an alarm, that function must be enabled with Programming Step 71 or 72.**

STEP #68 The output can be programmed to be a steady output using this step.

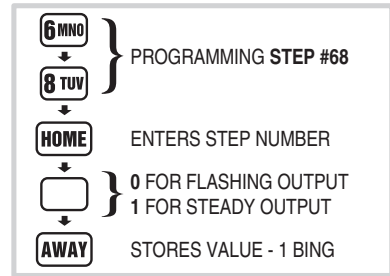

AUTOMATION ACTIVATION TONE

- ◆ The factory setting causes the keypad(s) to sound a “Bing” when the Automation Output is activated by pressing the **(A)** key, or when it's triggered with a two-button remote control.

STEP #69 This sound can be silenced using this step.

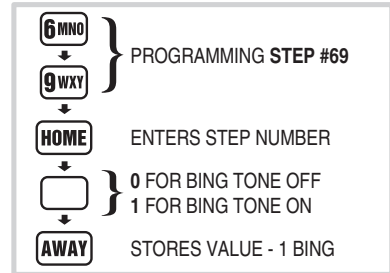

REMOTE CONTROL & HARDWIRE ARM/DISARM CHIRP

- ◆ When arming with the portable remote control or with a hardwired loop programmed as arm/disarm (sensor Function #9), the factory setting causes the keypad(s) to “chirp” once when armed, twice when disarmed, and three times when arming with sensors bypassed.

STEP #70 These chirps can be silenced using this step.

 **NOTE: If these chirps are silenced, it is recommended to program the Automation Output to be active when the system is armed, so a light can be triggered displaying the arming status of the system.**

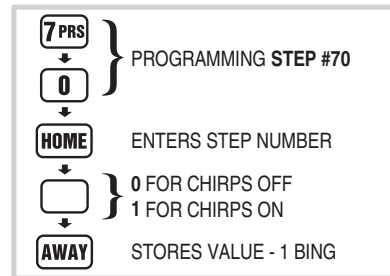

AUTOMATION OUTPUT ON DURING AND AFTER ALARM

- ◆ The factory setting causes the Control Panel's Automation Output to activate when pressing the **(A)** key, or when it's triggered with a two-button remote control.

STEP #71 The Control Panel can be programmed to activate the Automation Output during and after any alarms as well as when normally triggered using this step.

 **NOTE: The output will continue until the flashing sensor status lights are cleared.**

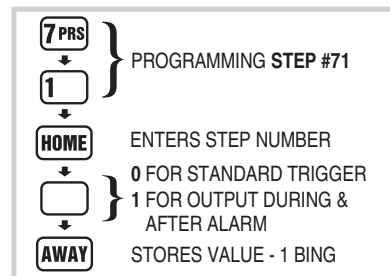

AUTOMATION OUTPUT ON DURING ALARM

- ◆ The factory setting causes the Control Panel's Automation Output to activate when pressing the **(A)** key, or when it's triggered with a two-button remote control.

STEP #72 The Control Panel can be programmed to activate the Automation Output during alarms as well as when normally triggered using this step.

 **NOTE: The Automation Output can be programmed to flash or be steady during alarm, see Programming Step 68.**

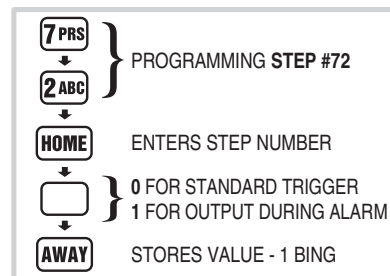

AUTOMATION OUTPUT WHILE ARMED

- ◆ The factory setting causes the Control Panel's Automation Output to activate when pressing the **A** key, or when it's triggered with a two-button remote control.

STEP #73 The Control Panel can be programmed to activate the Automation Output when the system is armed as well as when normally triggered using this step.

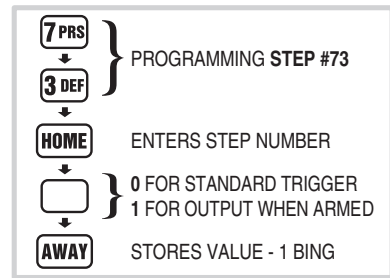

AUTOMATION OUTPUT DURING EXIT/ENTRY DELAYS

- ◆ The factory setting causes the Control Panel's Automation Output to activate when pressing the **A** key, or when it's triggered with a two-button remote control.

STEP #74 The Control Panel can be programmed to activate the Automation Output during the exit and Entry Delays as well as when normally triggered using this step.

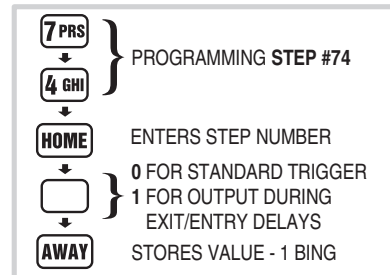

AUTOMATION OUTPUT POLARITY

- ◆ The factory setting causes the Control Panel's Automation Output to provide a current limited voltage source when activated.

STEP #75 The Control Panel can be programmed so the Automation Output provides a current limited voltage source when *deactivated* using this step.

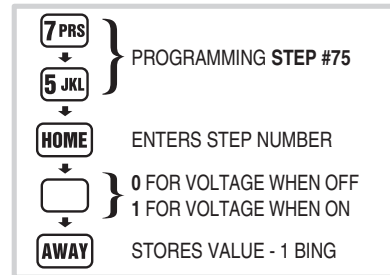

REMOTE ACCESS PASSWORD

- ◆ This password is used to gain access to the Control Panel when using the RA-2400 remote access software. The password must be 6-digits long.

STEP #87 Use this step to enter a new remote access password then log the password in the box below.

REMOTE ACCESS PASSWORD:

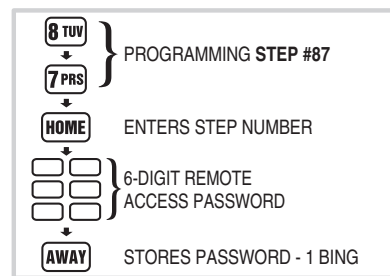

DURESS CODE

- ◆ The duress code will disarm the system, without any special indications or sounds, but will send the programmed duress code to the Central Station. The code should be two or more digits different than any user code

STEP #92 Use this step to enter the duress code then log the code in the box below.

DURESS CODE:

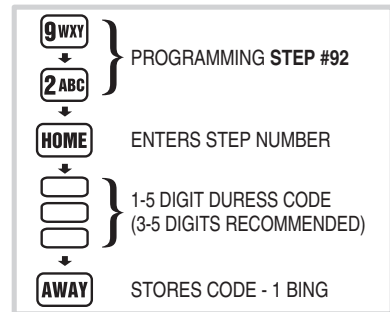

MASTER USER CODE

- ◆ The master user code is 1234 when power is first applied to the Control Panel.
- ◆ The master user code can be changed to any 1-5 digit code. Only the master user can access Setup Mode, restricted users cannot.

NOTE: For maximum security, a 3-5 digit code is recommended.

STEP #99 Use this step to enter the new master user code then log the code in the box below.

MASTER USER CODE:

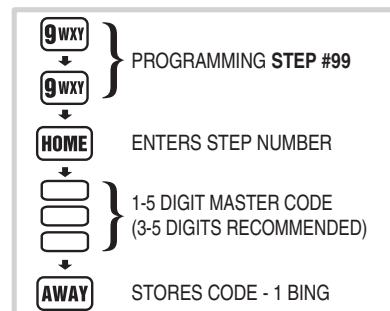

ADDING ADDITIONAL USER CODES

- ◆ The Control Panel can be programmed with five restricted user codes and one page alert user code.
 - ◆ The restricted user codes operate the system as usual, but cannot access Setup Mode.
 - ◆ The restricted user codes can access a special Code Mode that can be used to change or remove any of the five restricted user codes, the page alert user code, or the duress code.
 - ◆ The page alert user code dials the supervisory number (programmed for a pager) when it is used to arm or disarm the system.
 - ◆ A restricted user code is appropriate to give any user that should be restricted from programming the Control Panel.
- 📌 **NOTE: For maximum security, a 3-5 digit code is recommended.**
- 📌 **WARNING: NEVER PROGRAM ANY RESTRICTED USER CODE THE SAME AS THE MASTER USER CODE!**

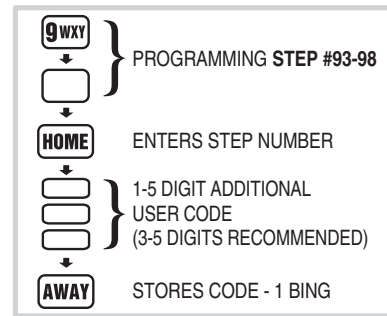

STEP	CODE FUNCTION	CODE ENTERED
STEP #93	RESTRICTED USER CODE #1	
STEP #94	RESTRICTED USER CODE #2	
STEP #95	RESTRICTED USER CODE #3	
STEP #96	RESTRICTED USER CODE #4	
STEP #97	RESTRICTED USER CODE #5	
STEP #98	PAGE ALERT USER CODE	

STEPS #93-98 Create any additional user codes using these steps then log the codes in the boxes to the right.

REMOVING ADDITIONAL USER CODES

- STEPS #93-98 Any additional user code can be removed from the Control Panel by entering the appropriate step number and pressing TEST.
- ◆ Because access to programming would be impossible without a master user code, it cannot be removed using these steps. The master user code can be changed using programming STEP #99.
- 📌 **NOTE: The master user code can be set to the factory default using the Control Panel master reset programming step, although all other system programming will be reset to factory values and all sensors programmed will be erased.**

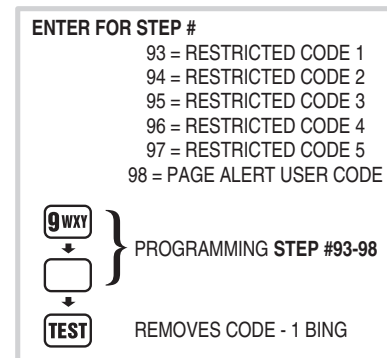

CONTROL PANEL MASTER RESET

- ◆ Master resetting the Control Panel will set all of the programming options back to the factory values. The master user code will be reset to 1234.
- 📌 **CAUTION: Master resetting the Control Panel will erase the user codes and remove all programmed sensors. All Control Panel and communicator programming values will be reset to the factory defaults.**
1. Start with the system in Test Mode (Setup Mode cannot be reached from any other mode).
 2. From Test Mode, enter the master user code then press TEST.
 - * A "Gong" and five "Beeps" will sound, signaling that the system is in Setup Mode.
 3. Enter programming STEP #999 then press TEST.
 4. Enter 999 again then press TEST again.
 - * A "Bing" will sound to indicate the beginning of the reset process. This process will take up to 10 seconds while the memory is being reset.
- ◆ The system will revert to the first time power-up condition and the new master user code will be 1234. Go to the "Basic Control Panel Programming" section of this manual to begin re-programming the system.

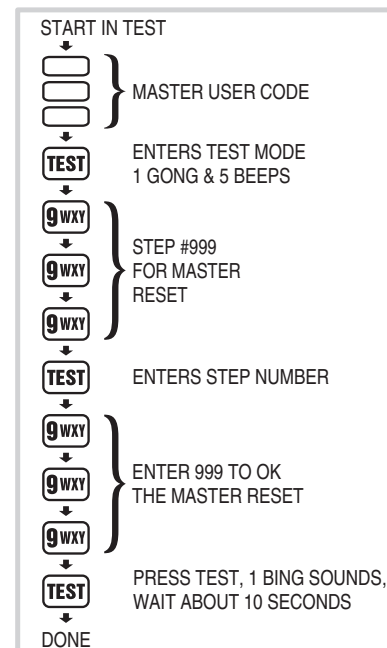

USE THESE EXACT KEYSTROKES TO PERFORM A MASTER RESET

14. COMMUNICATOR PROGRAMMING

- ◆ To perform any of the advanced programming steps, the system must be in the Setup Mode.
- ◆ Each programming function is performed with similar keystrokes. After the system is in Setup Mode, enter the programming step number and press **HOME**, then enter the new value and press **AWAY**. For reference, follow the figures next to the programming steps.
 - * If the new value is accepted, a “Bing” will sound. If the new value is not accepted, a “Double Buzz” will sound.



SETUP MODE

1. Start with the system in Test Mode (Setup Mode cannot be reached from any other mode).
2. From Test Mode, enter the master user code then press **TEST**.
 - 📎 **NOTE: Only the master user code can be used to put the system into the Setup Mode. The restricted user codes cannot access Setup Mode, only Code Mode.**
 - * A “Gong” and five “Beeps” will sound, signaling that the system is in Setup Mode.
3. After programming changes are complete, press the **OFF** key for three seconds to exit Setup Mode.
 - 📎 **NOTE: If the system is left unattended in Setup Mode, it will automatically switch back to Off Mode after three minutes.**

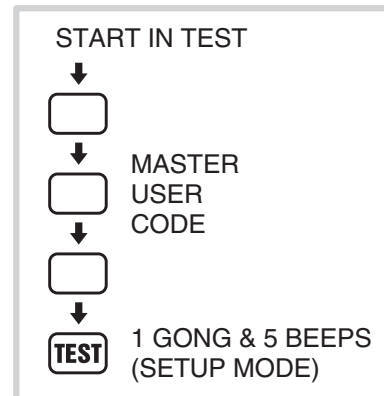

GENERAL COMMUNICATOR OPTIONS				
STEP #	PROGRAMMING FUNCTION	POSSIBLE VALUES	FACTORY VALUE	INSTALLATION VALUE
76	2-WAY AUDIO	0 = NONE; 1 = LISTEN; 2 = 2-WAY MANUAL; 3 = 2-WAY FULL DUPLEX	0	
78	VOICE RESPONSE FROM KEYPAD SPEAKER	0 = VOICE RESPONSE DISABLED 1 = VOICE RESPONSE ENABLED	0	
100	REMOTE PROGRAMMING LOCKOUT	0 = UNLOCK; 1 = LOCK	0	
101	CALL LIMITER	0 = OFF; 1 = FIVE CALLS PER ARMING PERIOD	0	
103	DIALING DELAY	0 = NO DELAY; 1 = 30 SECOND DELAY	0	
104	DIALING METHOD	0 = TONE; 1 = PULSE	0	
107	COMMUNICATOR ENABLE	0 = COMMUNICATOR OFF; 1 = COMMUNICATOR ON	0	

General Communicator Programming Table

COMMUNICATOR ENABLE

- ◆ The factory setting for the Control Panel disables the communicator. If the system is going to be a non-monitored, local alarm only, leave the communicator disabled.

STEP #107 If the system is going to be monitored by a Central Station, enable the communicator with this programming step.

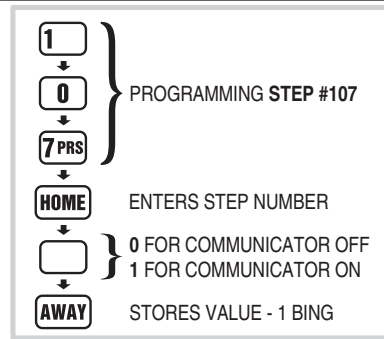

2-WAY AUDIO

- ◆ When the Model VB-2 voice module is installed, the communicator can provide 2-way audio capability.
- ◆ The audio module can be programmed for listen-only, 2-way manual operation (using a pushbutton telephone at the Central Station), and 2-way full duplex hands free operation.
- ◆ Refer to the VB-2 installation instructions for details on operating the audio module.

NOTE: The Model VB-2 digital voice response module must be installed for this option to function.

- ◆ The factory setting for the VB-2 audio module is OFF.

STEP #76 The audio module can be set for (1) listen-only, (2) 2-way manual, (3) 2-way full duplex using this step.

NOTE: For safety, 2-way audio will not activate if the system is disarmed with the duress code.

NOTE: Units programmed for two-way duplex can still be controlled manually by pressing the "1" or "3" key. In addition, the Central Station can return the unit to two-way duplex by pressing the "8" key.

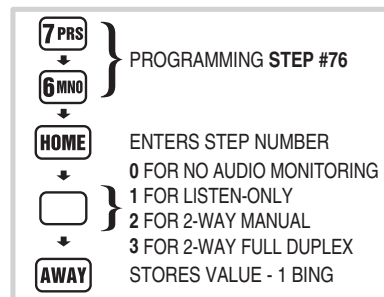

VOICE RESPONSE

- ◆ The Control Panel can be programmed to allow the keypad(s) speaker to play audio produced by the VB-2 digital voice response module.
- ◆ This selection can also be used when a remote speaker is connected to the Control Panel.
- ◆ The factory setting is to disable the keypad(s) speaker from playing voice module audio.

STEP #78 The Control Panel can be programmed to enable voice module audio using this step.

NOTE: Turning voice response OFF with this programming step will only effect the audio produced by the voice module. It will not stop the keypad(s) speaker from sounding local sirens and tones.

NOTE: A Model VB-2 digital voice response module must be installed for this option to function.

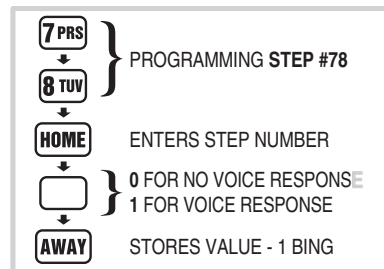

REMOTE LOCKOUT

- ◆ The factory setting for the communicator allows remote connection to the Control Panel with Linear's RA-2400 Remote Access Software and a modem (unlocked).

STEP #100 The Control Panel can be programmed to not answer incoming calls, thereby, not allowing remote access (locked) using this step.

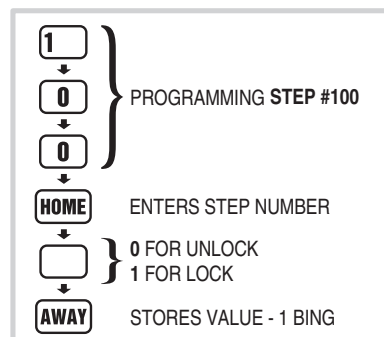

CALL LIMITER

- ◆ The factory setting for the call limiter is OFF. This allows the communicator to report burglary alarms, once for each sensor, as many times as they are triggered.

STEP #101 The Control Panel can be programmed to only allow five burglary reports total per arming period using this step.

- 📎 **NOTE: Sensors programmed for 24-hour functions (Emergency, Panic, Fire) always send a Central Station report and always sound the local siren regardless of the Call Limiter setting.**

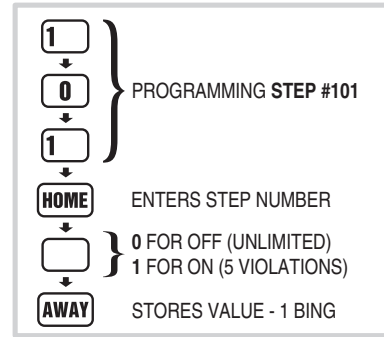

DIALING DELAY

- ◆ The factory setting will cause the communicator to dial the Central Station instantly when an alarm or supervisory event occurs.

STEP #103 The communicator can be programmed to wait 30 seconds before dialing using this step. This gives the user time to disarm the system and prevent communications in the case of a subscriber generated false alarm.

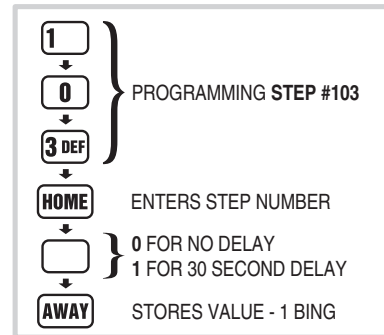

DIALING METHOD

- ◆ The factory setting causes the communicator to dial using DTMF (dual-tone multi-frequency) tone dialing.

STEP #104 The communicator can be programmed to use pulse (rotary) dialing using this step. Use this option if the telephone line in the installation does not support tone dialing.

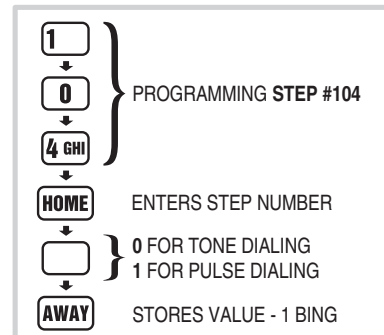

COMMUNICATOR REPORTING OPTIONS

REPORTING FORMAT

- ◆ The factory setting causes the communicator to report using the **4 BY 2 FORMAT**. This format allows four-digit account numbers from 0000 to 9999 and provides two-digit alarm codes.

STEP #105 ADEMCO CONTACT ID can be chosen as a reporting format using this step. This format allows 4-digit account numbers from 0000 to 9999 and provides verbose report descriptions with Ademco Contact ID compatible Central Stations.

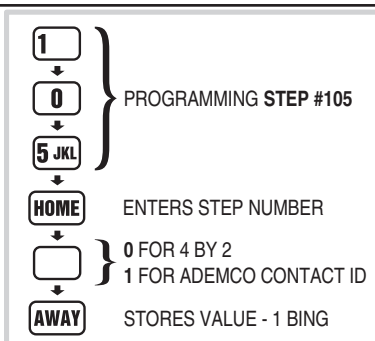

CALL ROUTING

- ◆ The communicator can be programmed with three telephone numbers; primary, secondary, and supervisory.
- ◆ The factory setting for the communicator is to route all calls to the primary telephone number. If communication is unsuccessful after five attempts to the primary number, the secondary number will be dialed for an additional five attempts. If the secondary number cannot be reached, the communicator will “sleep” for five minutes before starting the call process over again. A total of four sleep cycles (50 call attempts) can occur before the communicator stops calling.

STEP #86 The communicator can be programmed to report supervisory events (low battery, trouble, AC failure, etc.) to the supervisory telephone number instead of the primary or secondary telephone numbers using this step.

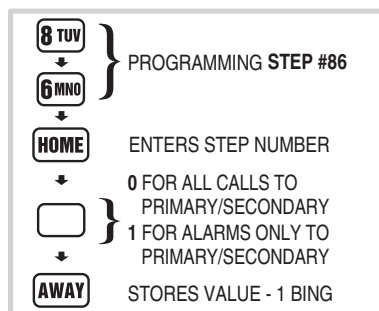

CAUTION: If the page alert user code feature is going to be used, the supervisory number is reserved for the pager number. DO NOT SET THE CALL ROUTING OPTION TO “1”.

NOTE: To disable supervisory reports, set call routing option to “1” and remove the supervisory telephone number.

NOTE: Do not program the primary and secondary telephone numbers the same. See the FCC Telephone Rules and Regulations on the rear cover of this manual.

COMMUNICATOR REPORTING OPTIONS				
STEP #	PROGRAMMING FUNCTION	POSSIBLE VALUES	FACTORY VALUE	INSTALLATION VALUE
86	CALL ROUTING	0 = ALL CALLS TO PRIMARY OR SECONDARY NUMBER 1 = ALL ALARM CALLS TO PRIMARY OR SECONDARY NUMBER AND ALL OTHERS TO SUPERVISORY NUMBER	0	
88	ACCOUNT NUMBER	4 DIGITS	EMPTY	
89	PRIMARY PHONE NUMBER	UP TO 20 DIGITS	EMPTY	
90	SECONDARY PHONE NUMBER	UP TO 20 DIGITS	EMPTY	
91	SUPERVISORY/PAGER PHONE NUMBER	UP TO 20 DIGITS	EMPTY	
	FOR ALL PHONE NUMBERS ⇒ ⇒ ⇒	PRESSING THE (A) KEY INSERTS A 1-SECOND DELAY THE [FIRE] KEY INSERTS A 5-SECOND DELAY THE [CHIME] KEY INSERTS A “*” THE (A) KEY INSERTS A “#” IF IT IS THE LAST DIGIT OF THE PHONE NUMBER		
105	REPORTING FORMAT	0 = 4 BY 2; 1 = ADEMCO	0	
108	REPORT SYSTEM TROUBLE	0 = NO; 1 = YES	0	
110	REPORT FORCE ARMING	0 = NO; 1 = YES	0	
111	OPEN/CLOSE	0 = NO; 1 = YES; 2 = MASTER PAC ONLY	0	
113	POINT ID REPORTING FOR 4 BY 2 FORMAT	0 = NO; 1 = YES	1	

Communicator Reporting Option Table

ACCOUNT NUMBER

- ◆ The account number entered for the communicator must be 4-digits long.
- ◆ The factory setting for the account number is 0000.

STEP #88 Enter an account number from 0000 to 9999 using this step.

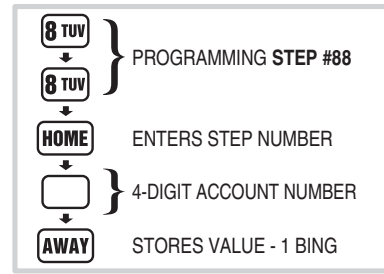

PRIMARY TELEPHONE NUMBER

- ◆ The primary Central Station telephone number can be up to 20-digits long.
- ◆ Digits 0-9 can be used.
- ◆ Delays and special characters can be entered in the telephone number (see below).

STEP #89 Enter the primary telephone number using this step.

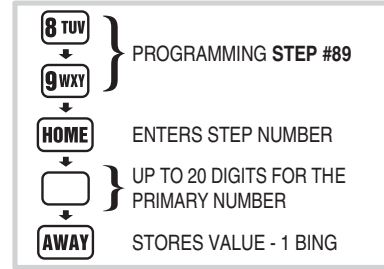

SECONDARY TELEPHONE NUMBER

- ◆ The secondary Central Station telephone number can be up to 20-digits long.
- ◆ Digits 0-9 can be used.
- ◆ Delays and special characters can be entered in the telephone number (see below).

STEP #90 Enter the secondary telephone number using this step.

NOTE: To remove the secondary telephone number, enter step number 90 then press TEST.

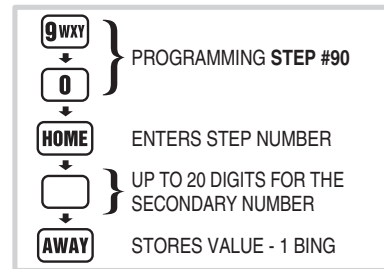

SUPERVISORY OR PAGER TELEPHONE NUMBER

- ◆ The supervisory Central Station or pager telephone number can be up to 20-digits long.
- ◆ Digits 0-9 can be used.
- ◆ Delays and special characters can be entered in the telephone number (see below). If this is a pager number, enter enough delays for the phone to answer. Then, enter the number to be dialed.
- ◆ End a pager number with the completion character (usually a pound (#) character).

STEP #91 Enter the supervisory or pager telephone number using this step.

NOTE: To remove the supervisory/pager telephone number, enter step number 91 then press TEST.

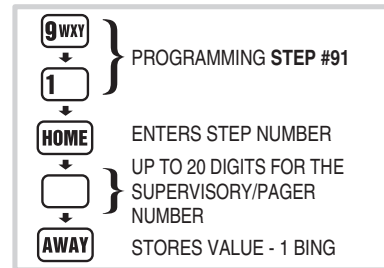

TELEPHONE NUMBER DELAYS AND SPECIAL CHARACTERS

- ◆ When creating telephone numbers with programming Steps 89, 90, & 91, use the following keys to add dialing delays or special characters.
- ◆ Press the **A** key to place a 1-second dialing delay at the start or anywhere in the middle of the telephone number.
- ◆ Pressing the **A** key as the last digit of the telephone number will place a pound # character at the end of the telephone number.
- ◆ Press the **FIRE** key to place a 5-second dialing delay anywhere in the telephone number.
- ◆ Press the **CHIME** key to place a star * character anywhere in the telephone number.

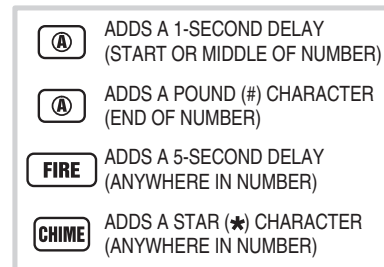

REPORT CONTROL PANEL TROUBLE

- ◆ The factory setting does not report Control Panel trouble events to the Central Station.

STEP #108 The communicator can be programmed to report Control Panel trouble events using this step. These include all conditions that light the keypad(s) **BATTERIES** or **TROUBLE** indicator. It also includes low Control Panel backup battery.

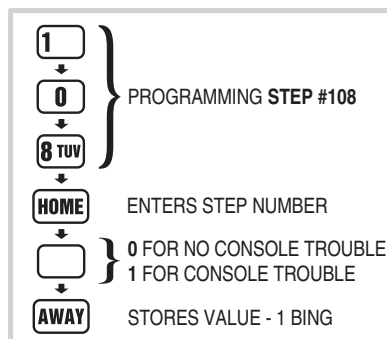

REPORT FORCE ARMING

- ◆ The factory setting does not send force arming reports.

STEP #110 The communicator can be programmed to report force arming anytime the Control Panel is armed with one or more bypassed sensors using this step.

- ◆ The factory set reporting code for force arming is "65" (Code 574 with Ademco).

NOTE: *If force arming is enabled, and the Control Panel is force armed (armed with an open sensor) remotely by telephone, or with the RA-2400 Remote Access software, the caller will be disconnected if the communicator is enabled.*

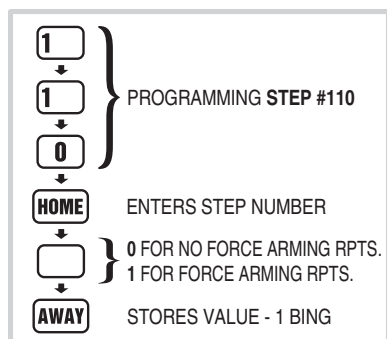

OPENING AND CLOSING REPORTS

- ◆ The factory setting does not send opening and closing reports.

STEP #111 The communicator can be programmed to send an opening report when the system is disarmed, and a closing report when the system is armed for all users, or just the master user using this step.

NOTE 1: *For commercial installations with retail traffic using opening and closing reports, it is recommended to disable quick arming to prevent customers from arming the system.*

NOTE 2: *The reporting codes are fixed for opening and closing. A unique code is reserved for the master user code and each of the five restricted user codes.*

NOTE 3: *Arming or disarming with the page alert user code dials the supervisory number, no opening or closing report is sent.*

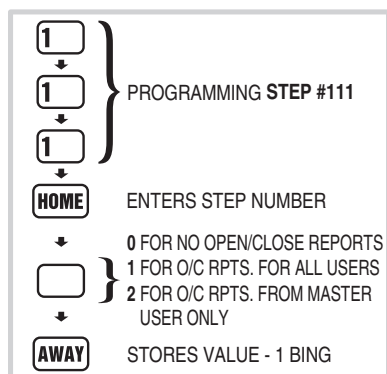

POINT ID REPORTING

- ◆ The factory setting enables Point ID and allows the communicator to send two-digit alarm and trouble codes for each sensor. The individual sensor that causes an alarm or trouble report can be identified at the Central Station.

STEP #113 Point ID can be disabled using this step. The Central Station will only receive general alarm and trouble reports.

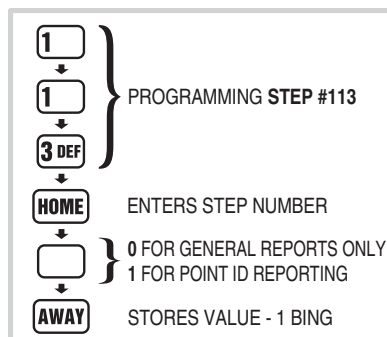

COMMUNICATOR REPORTING CODES

- ◆ The 4 by 2 two-digit communicator reporting code for each event has a factory set value. These values may be customized to fit the specific installation and the reporting requirements of the Central Station monitoring the system.
- ◆ If Point ID reporting is enabled (the factory default setting), each sensor can report a unique alarm and trouble code.
- ◆ If Point ID is disabled, the “general” reporting codes for each event type will be used.
- ◆ Each programming function is performed with similar keystrokes. After the system is in Setup Mode, enter the programming step number and press **HOME**, then enter the new value and press **AWAY**. For reference, follow the figures next to the programming steps.
 - * If the new value is accepted, a “Bing” will sound. If the new value is not accepted, a “Double Buzz” will sound.
- ◆ Making a value 0 causes the event not to communicate to the Central Station.
- ✎ **NOTE: The reporting codes are fixed for opening and closing. A unique code is reserved for the master and the five restricted user codes. See the Opening & Closing Reporting Codes Table.**

ADEMCO REPORTING CODES		
EVENT	ALARM CODE	EXTENDED CODE
SENSOR EMERGENCY	E120	C0xx
CONSOLE EMERGENCY	E120	C026
SENSOR FIRE	E111	C0xx
CONSOLE FIRE	E110	C025
BURGLARY ALARM	E130	C0xx
SILENT PANIC	E122	C0xx
FORCE ARM	E574	C000
DURESS	E121	C000
CANCEL	E406	C000
SENSOR LOW BATTERY	E384	C0xx
SENSOR STATUS TROUBLE	E381	C0xx
CONSOLE LOW BATTERY	E302	C000
CONSOLE BATTERY RESTORE	R302	C000
2-WAY AUDIO	E606	C000
xx = SENSOR NUMBER IN EXTENDED REPORT		

HOME

ENTERS PROGRAM STEP NUMBER TO MODIFY

AWAY

STORES NEW VALUE

GENERAL REPORTING CODES

- ◆ Use program Steps #201 - 206 to change the communicator reporting codes when Point ID is disabled.
- ◆ Refer to the General Reporting Codes table to view/edit the reporting codes for each of the five events. The factory settings are listed, along with a blank area to write in the new installation values.

STEPS #201-206

Any value from 0-99 can be programmed for each event using these steps (enter “0” to stop an event from reporting).

- ✎ **NOTE: Be careful not to duplicate codes unless the Central Station requires specific codes for certain types of events.**

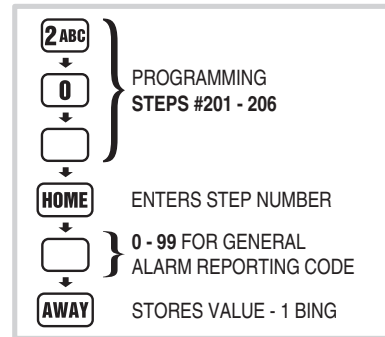

GENERAL REPORTING CODES				
STEP #	PROGRAMMING FUNCTION	POSSIBLE 4 BY 2 VALUES	FACTORY 4 BY 2 VALUES	INSTALLATION 4 BY 2 VALUE
201	GENERAL FIRE REPORT CODE	0 - 99	1	
202	GENERAL EMERGENCY REPORT CODE	0 - 99	2	
203	GENERAL SILENT PANIC REPORT CODE	0 - 99	3	
204	GENERAL BURGLARY REPORT CODE	0 - 99	4	
206	GENERAL TROUBLE REPORT CODE	0 - 99	6	

General Reporting Codes Table

SYSTEM REPORTING CODES

- ◆ Refer to the System Reporting Codes table to view/edit the reporting codes for the keypad **FIRE** and **EMERGENCY** buttons and for each of the three Control Panel conditions. The factory settings are listed, along with a blank area to write in the new installation values.

STEPS #261-266

Any value from 0-99 can be programmed for each event using these steps (enter "0" to stop an event from reporting).

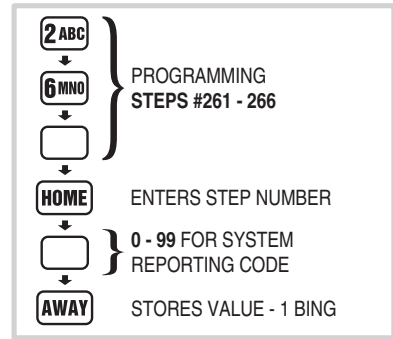

FORCE ARMING REPORTING CODE

- ◆ The factory set reporting code for force arming is "65" (Code 574 with Ademco).

STEP #258 Any value from 0-99 can be programmed for this event using this step (0 = no report).

- ✎ **NOTE: For force arming reporting, force arming reports must be enabled. See Page 41.**

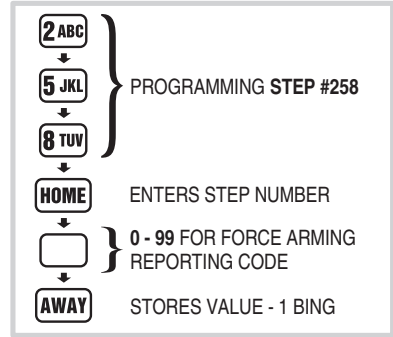

DURESS REPORTING CODE

- ◆ The factory set reporting code for Duress is "66" (Code 121 with Ademco).

STEP #259 Any value from 0-99 can be programmed for this event using this step (0 = no report).

- ✎ **NOTE: For duress code reporting a keypad duress code must be programmed. See Page 34.**

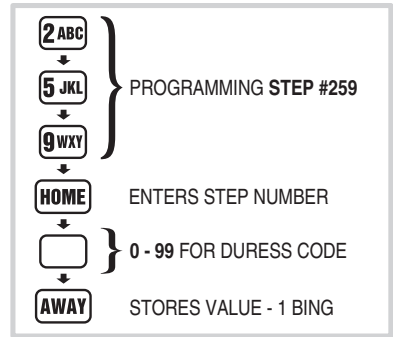

SYSTEM REPORTING CODES					
STEP #	PROGRAMMING FUNCTION	POSSIBLE 4 BY 2 VALUES	FACTORY 4 BY 2 VALUES	ADEMCO VALUE	INSTALLATION 4 BY 2 VALUE
258	FORCE ARMING REPORT CODE	0 - 99	65	574	
259	DURESS REPORT CODE	0 - 99	66	121	
261	SYSTEM FIRE REPORT CODE	0 - 99	68	110	
262	SYSTEM EMERGENCY REPORT CODE	0 - 99	69	120	
263	SYSTEM TEST/CANCEL REPORT CODE	0 - 99	70	406	
264	SYSTEM LOW BATTERY RESTORAL REPORT CODE	0 - 99	71	R302	
265	SYSTEM LOW BATTERY CODE	0 - 99	73	E302	

System Reporting Codes Table

OPENING & CLOSING REPORTING CODES TABLE				
USER CODE	4 x 2 CLOSING (ARMING) CODE	4 x 2 OPENING (DISARMING) CODE	ADEMCO CLOSING (ARMING) CODE	ADEMCO OPENING (DISARMING) CODE
MASTER USER CODE1	74	82	R401 C000	E401 C000
RESTRICTED USER CODE #1	75	83	R401 C001	E401 C001
RESTRICTED USER CODE #2	76	84	R401 C002	E401 C002
RESTRICTED USER CODE #3	77	85	R401 C003	E401 C003
RESTRICTED USER CODE #4	78	86	R401 C004	E401 C004
RESTRICTED USER CODE #5	79	87	R401 C005	E401 C005
PAGE ALERT USER CODE	(DIALS PAGE NUMBER ONLY, NO CODES REPORTED)			
REMOTE/HARDWIRE ARM (SENSOR FCN. 9) & QUICK ARM	81		R407 C007	
REMOTE/HARDWIRE DISARM (SENSOR FCN. 9)		89		E407 C007

Opening & Closing Reporting Codes Table

4 BY 2 FORMAT POINT ID ALARM REPORT CODES

- ◆ Refer to the 4 by 2 Format Point ID Reporting Code table to view/edit the alarm reporting codes for each of the 24 sensors. The communicator will send these codes if Point ID is enabled and any sensor triggers an alarm. The factory settings are listed, along with a blank area to write in the new installation values.
- ◆ Use program Steps #210 - 233 to change the 4 by 2 Point ID alarm reporting codes.
- ✎ **NOTE: Be careful not to duplicate codes unless the Central Station requires specific codes for certain types of sensors.**

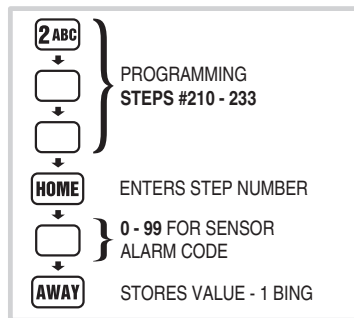

STEPS #210-233

Any value from 0-99 can be programmed for each event using these steps (enter "0" to stop an event from reporting).

4 BY 2 FORMAT POINT ID TROUBLE REPORT CODES

- ◆ Refer to the 4 by 2 Format Point ID Reporting Code table to view/edit the trouble reporting codes for each of the 24 sensors. The communicator will send these codes if Point ID is enabled and any sensor has a low battery or trouble condition. The factory settings are listed, along with a blank area to write in the new installation values.
- ◆ Use program Steps #234 - 257 to change the 4 by 2 Point ID trouble reporting codes.
- ✎ **NOTE: Be careful not to duplicate codes unless the Central Station requires specific codes for certain types of sensors.**

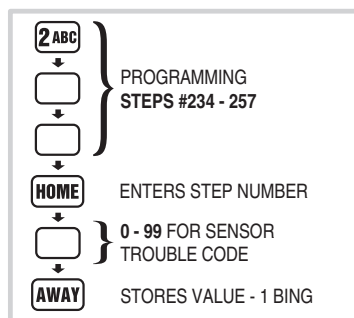

STEPS #234-257

Any value from 0-99 can be programmed for each event using these steps (enter "0" to stop an event from reporting).

4 BY 2 FORMAT POINT ID REPORTING CODES

STEP #	PROGRAMMING FUNCTION	POSSIBLE 4 BY 2 VALUES	FACTORY 4 BY 2 VALUE	INSTALLATION 4 BY 2 VALUE
210	SENSOR 1 ALARM REPORT CODE	0 - 99	11	
211	SENSOR 2 ALARM REPORT CODE	0 - 99	12	
212	SENSOR 3 ALARM REPORT CODE	0 - 99	13	
213	SENSOR 4 ALARM REPORT CODE	0 - 99	14	
214	SENSOR 5 ALARM REPORT CODE	0 - 99	15	
215	SENSOR 6 ALARM REPORT CODE	0 - 99	16	
216	SENSOR 7 ALARM REPORT CODE	0 - 99	17	
217	SENSOR 8 ALARM REPORT CODE	0 - 99	18	
218	SENSOR 9 ALARM REPORT CODE	0 - 99	19	
219	SENSOR 10 ALARM REPORT CODE	0 - 99	20	
220	SENSOR 11 ALARM REPORT CODE	0 - 99	21	
221	SENSOR 12 ALARM REPORT CODE	0 - 99	22	
222	SENSOR 13 ALARM REPORT CODE	0 - 99	23	
223	SENSOR 14 ALARM REPORT CODE	0 - 99	24	
224	SENSOR 15 ALARM REPORT CODE	0 - 99	25	
225	SENSOR 16 ALARM REPORT CODE	0 - 99	26	
226	SENSOR 17 ALARM REPORT CODE	0 - 99	27	
227	SENSOR 18 ALARM REPORT CODE	0 - 99	28	
228	SENSOR 19 ALARM REPORT CODE	0 - 99	29	
229	SENSOR 20 ALARM REPORT CODE	0 - 99	30	
230	SENSOR 21 ALARM REPORT CODE	0 - 99	31	
231	SENSOR 22 ALARM REPORT CODE	0 - 99	32	
232	SENSOR 23 ALARM REPORT CODE	0 - 99	33	
233	SENSOR 24 ALARM REPORT CODE	0 - 99	34	
234	SENSOR 1 TROUBLE REPORT CODE	0 - 99	41	
235	SENSOR 2 TROUBLE REPORT CODE	0 - 99	42	
236	SENSOR 3 TROUBLE REPORT CODE	0 - 99	43	
237	SENSOR 4 TROUBLE REPORT CODE	0 - 99	44	
238	SENSOR 5 TROUBLE REPORT CODE	0 - 99	45	
239	SENSOR 6 TROUBLE REPORT CODE	0 - 99	46	
240	SENSOR 7 TROUBLE REPORT CODE	0 - 99	47	
241	SENSOR 8 TROUBLE REPORT CODE	0 - 99	48	
242	SENSOR 9 TROUBLE REPORT CODE	0 - 99	49	
243	SENSOR 10 TROUBLE REPORT CODE	0 - 99	50	
244	SENSOR 11 TROUBLE REPORT CODE	0 - 99	51	
245	SENSOR 12 TROUBLE REPORT CODE	0 - 99	52	
246	SENSOR 13 TROUBLE REPORT CODE	0 - 99	53	
247	SENSOR 14 TROUBLE REPORT CODE	0 - 99	54	
248	SENSOR 15 TROUBLE REPORT CODE	0 - 99	55	
249	SENSOR 16 TROUBLE REPORT CODE	0 - 99	56	
250	SENSOR 17 TROUBLE REPORT CODE	0 - 99	57	
251	SENSOR 18 TROUBLE REPORT CODE	0 - 99	58	
252	SENSOR 19 TROUBLE REPORT CODE	0 - 99	59	
253	SENSOR 20 TROUBLE REPORT CODE	0 - 99	60	
254	SENSOR 21 TROUBLE REPORT CODE	0 - 99	61	
255	SENSOR 22 TROUBLE REPORT CODE	0 - 99	62	
256	SENSOR 23 TROUBLE REPORT CODE	0 - 99	63	
257	SENSOR 24 TROUBLE REPORT CODE	0 - 99	64	

4 by 2 Format Point ID Reporting Code Table

IMPORTANT INFORMATION

LINEAR LIMITED WARRANTY

This Linear product is warranted against defects in material and workmanship for twelve (12) months. **This warranty extends only to wholesale customers** who buy direct from Linear or through Linear's normal distribution channels. **Linear does not warrant this product to consumers.** Consumers should inquire from their selling dealer as to the nature of the dealer's warranty, if any. **There are no obligations or liabilities on the part of Linear LLC for consequential damages arising out of or in connection with use or performance of this product or other indirect damages with respect to loss of property, revenue, or profit, or cost of removal, installation, or reinstallation.** All implied warranties, including implied warranties for merchantability and implied warranties for fitness, are valid only until the warranty expires. **This Linear LLC Warranty is in lieu of all other warranties express or implied.**

All products returned for warranty service require a Return Product Authorization Number (RPA#). Contact Linear Technical Services at 1-800-421-1587 for an RPA# and other important details.

WIRELESS PRODUCT NOTICE

Linear radio controls provide a reliable communications link and fill an important need in portable wireless signaling. However, there are some limitations which must be observed.

- * For U.S. installations only: The radios are required to comply with FCC Rules and Regulations as Part 15 devices. As such, they have limited transmitter power and therefore limited range.
- * A receiver cannot respond to more than one transmitted signal at a time and may be blocked by radio signals that occur on or near their operating frequencies, regardless of code settings.
- * Changes or modifications to the device may void FCC compliance.
- * Infrequently used radio links should be tested regularly to protect against undetected interference or fault.
- * A general knowledge of radio and its vagaries should be gained prior to acting as a wholesale distributor or dealer, and these facts should be communicated to the ultimate users.

FCC NOTICE

This equipment generates and uses radio frequency energy and if not installed and used properly, that is, in strict accordance with the manufacturer's instructions, may cause interference to radio and television reception. It has been type tested and found to comply with the limits for a Class B computing device in accordance with Part 15 of FCC Rules, which are designed to provide reasonable protection against such interference in a residential installation. However, there is no guarantee that interference will not occur in a particular installation. If this equipment does cause interference to radio or television reception, which can be determined by turning the equipment off and on, the user is encouraged to try to correct the interference by one or more of the following measures:

- * Relocate the Control Panel away from the TV/radio receiver.
- * Plug the Control Panel into a different wall outlet so that the Control Panel is on a different branch circuit.
- * Re-orient the TV/radio antenna.
- * If necessary, the user should consult the dealer or an experienced radio/television technician for additional suggestions.

FCC TELEPHONE RULES AND REGULATIONS

The FCC requires that this alarm dialer system not make more than 15 repetitive dialing attempts to a single telephone number. There are no limitations when the calls are made sequentially to two or more alternative numbers, or when these calls are spaced 10 minutes apart to a single number. The FCC Rules and Regulations do not specify the re-attempt period as this can vary for specific applications. When setting this period, take into consideration local, interstate, foreign and special network call completion characteristics, network processing time, a sufficient number of rings and busy/don't answer modes.

FIRE EVACUATION PLANNING

For systems that include fire protection, UL requires that the following information be available to the users of the system.

- * Draw up a floor plan showing two exits for each room.

The following procedures are to be discussed with the family:

- ① Status of bedroom doors.
- ② Familiarity with alarm signals.
- ③ Testing of door during a fire and use of alternate escape route if door is hot to touch.
- ④ Crawling and holding breath.
- ⑤ Escape fast. No stopping for packing.
- ⑥ Meet at designated outdoor spot.
- ⑦ Emphasize that no one is to return to a burning house.
- ⑧ Fire department notification from a neighbor's phone.
- ⑨ Periodic rehearsal is to be conducted.

INDUSTRY CANADA NOTICES

NOTICE: The ringer equivalence number (REN) assigned to each terminal device provides an indication of the maximum number of terminals allowed to be connected to a telephone interface. The termination on an interface may consist of any combination of devices subject only to the requirement that the sum of the ringer equivalence numbers of all the devices does not exceed 5.

NOTICE: The Industry Canada label identifies certified equipment. This certification means that the equipment meets certain telecommunications network protective, operational and safety requirements. The Department does not guarantee the equipment will operate to the user's satisfaction.

Before installing this equipment, users should ensure that it is permissible to be connected to the facilities of the local telecommunications company. The equipment must also be installed using an acceptable method of connection. The customer should be aware that compliance with the above conditions may not prevent degradation of service in some situations.

Repairs to certified equipment should be made by an authorized Canadian maintenance facility designated by the supplier. Any repairs or alterations made by the user to this equipment, or equipment malfunctions, may give the telecommunications company cause to request the user to disconnect the equipment.

Users should ensure for their own protection that the electrical ground connections of the power utility, telephone lines and internal metallic water pipe system, if present, are connected together. This precaution may be particularly important in rural areas.

CAUTION: Users should not attempt to make such connections themselves, but should contact the appropriate electric inspection authority, or electrician, as appropriate.